

THIS DRAWING IS UNPUBLISHED.

RELEASED FOR PUBLICATION

-, 2005.

© COPYRIGHT 2005 By -

ALL RIGHTS RESERVED.

REVISIONS

P	LTR	DESCRIPTION	DATE	DWN	APVD
	D4	REVISED PER ECO-20-000020	2JAN2020	A.L	H.L

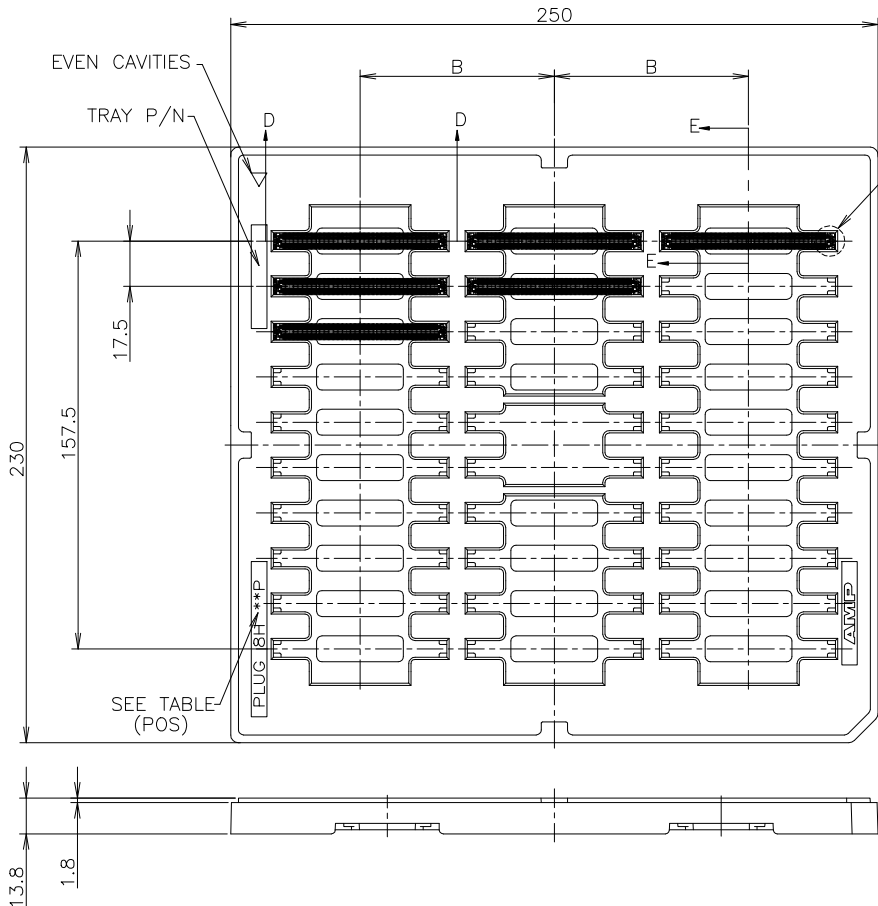

SEE DETAIL C

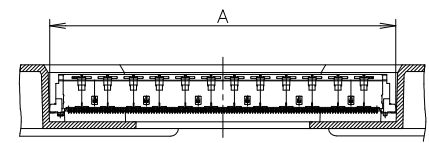

SECT. D-D (SCALE 2:1) (CONNECTOR NOT SECTION)

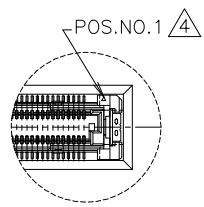

DETAIL C (SCALE 2:1)

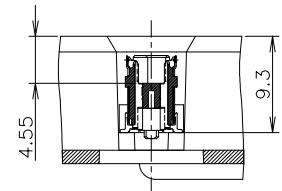

SECT. E-E (SCALE 2:1)

WITHOUT PICK UP CAP

THIS DRAWING IS A CONTROLLED DOCUMENT.

DIMENSIONS:	TOLERANCES UNLESS OTHERWISE SPECIFIED:
MM	
	0 PLC ± 0.3
	1 PLC ± 0.3
	2 PLC ± 0.3
	3 PLC ± 0.3
	4 PLC ± 0.3
	ANGLES ± 3'

DWN	S. CHIEN	26SEP05
CHK	T. FUTATSUGI	26SEP05
APVD	W. KODAMA	26SEP05
PRODUCT SPEC	108-5560	
APPLICATION SPEC		
WEIGHT		
CUSTOMER DRAWING		

YES Δ	3	30	75	61.8	220	8-6318491-6
NO	3	30	75	61.8	220	3-6318491-6
SEALANT	ROW	QTY	B	A	POS.	PART NO.

TE Connectivity Ltd.

NAME				HARD TRAY ASSY		
FH 0.5BTB CONNECTOR 220POS				PLUG 8H WITH GROUND PLATE		
SIZE	CAGE CODE	DRAWING NO	RESTRICTED TO			
A3	00779	C=6318491				
SCALE 1:2		SHEET 1 OF 5		REV D4		

4

3

2

1

THIS DRAWING IS UNPUBLISHED.

RELEASED FOR PUBLICATION

,2005.

© COPYRIGHT 2005 By -

ALL RIGHTS RESERVED.

REVISIONS

P	LTR	DESCRIPTION	DATE	DWN	APVD
-	-	SEE SHEET 1	-	-	-

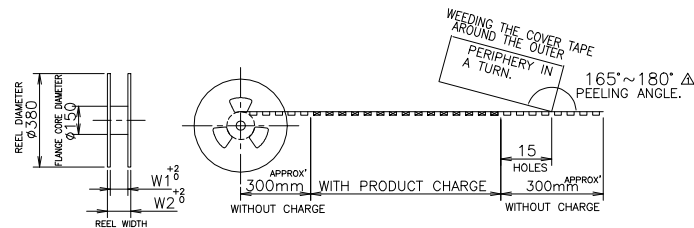
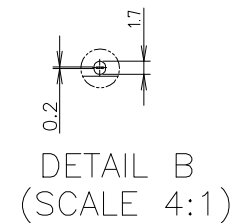
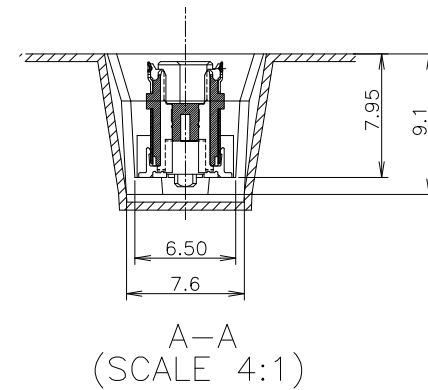
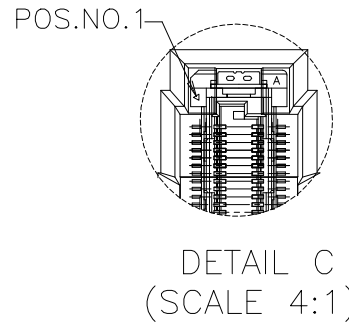
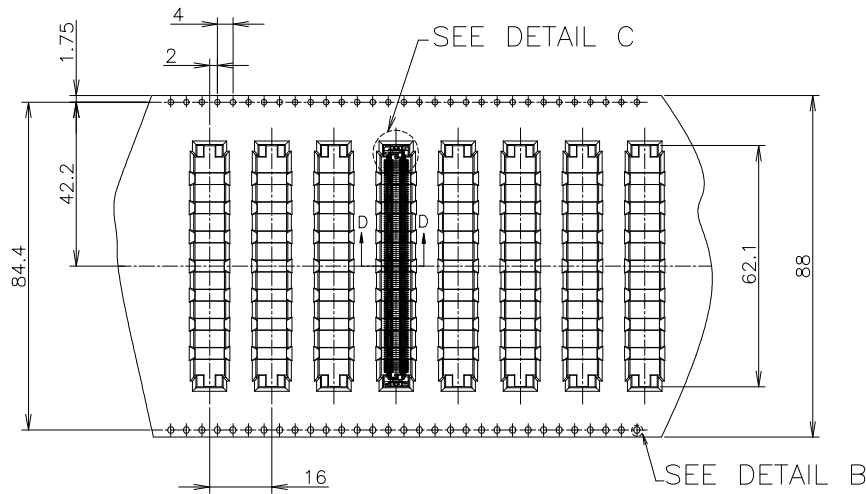

WITHOUT PICK UP CAP

NO	Y	400	93.5	88.5	220	2078455-1	3-5353619-6	4-6318491-6	
SEALANT	TOOLING AVAIL	QTY/REEL	W2	W1	POS.	EMBOSS P/N	CONN P/N	PART NO.	
THIS DRAWING IS A CONTROLLED DOCUMENT.						TE Connectivity Ltd.			
DIMENSIONS: MM		TOLERANCES UNLESS OTHERWISE SPECIFIED:		DWN S.CHIEN 26SEP05 CHK T.FUTATSUGI 26SEP05 APVD W.KODAMA 26SEP05		NAME			
		0 PLC ± 0.3 1 PLC ± 0.3 2 PLC ± 0.3 3 PLC ± 0.3 4 PLC ± 0.3 ANGLES ± 3°		PRODUCT SPEC 108-5560 APPLICATION SPEC		HARD TRAY ASSY FH 0.5BTB CONNECTOR 220POS PLUG 8H WITH GROUND PLATE			
MATERIAL		FINISH		WEIGHT		SIZE	CAGE CODE	DRAWING NO	RESTRICTED TO
						A3	00779	C=6318491	
CUSTOMER DRAWING						SCALE	SHEET	REV	
						1:2	2 OF 5	D4	

4

3

2

1

THIS DRAWING IS UNPUBLISHED.

RELEASED FOR PUBLICATION

,2005.

© COPYRIGHT 2005 By -

ALL RIGHTS RESERVED.

REVISIONS

P	LTR	DESCRIPTION	DATE	DWN	APVD
-	-	SEE SHEET 1	-	-	-

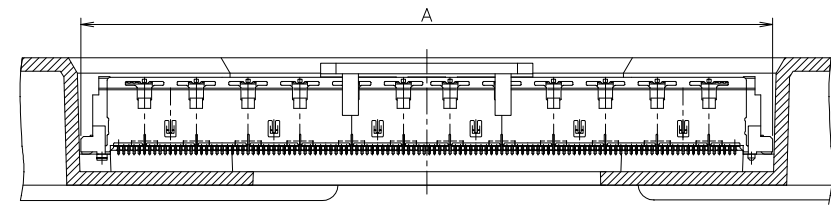
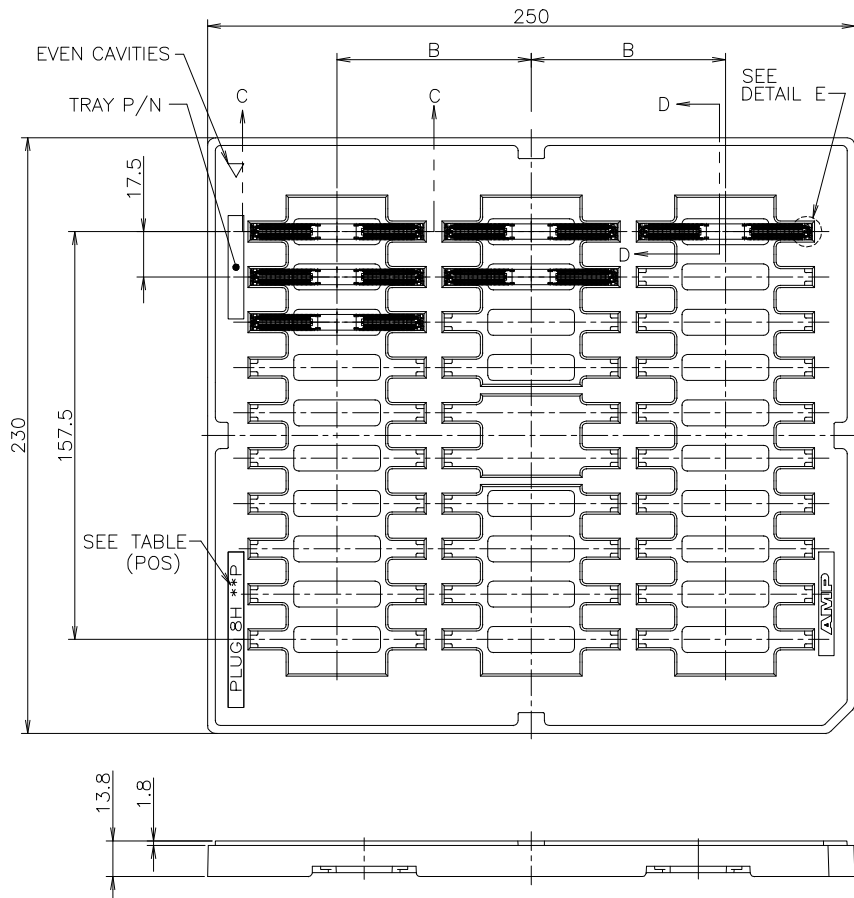

SECT. C-C (SCALE 2:1)

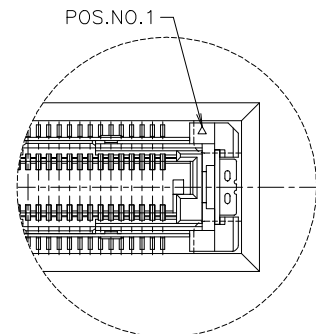

DETAIL E (SCALE 4:1)

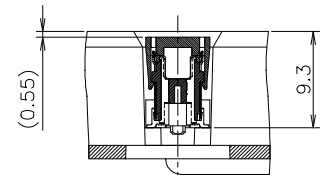

SECT. D-D (SCALE 2:1)

WITH PICK UP CAP

NATURAL	NO	3	30	75	61.8	220	6-6318491-6
BLACK	NO	3	30	75	61.8	220	9-6318491-6
CAP COLOR	SEALANT	ROW	QTY	B	A	POS.	PART NO.

THIS DRAWING IS A CONTROLLED DOCUMENT.

DIMENSIONS: MM	TOLERANCES UNLESS OTHERWISE SPECIFIED: 0 PLC ± 0.3 1 PLC ± 0.3 2 PLC ± 0.3 3 PLC ± 0.3 4 PLC ± 0.3 ANGLES ± 3'	DWN S.CHEN 26SEP05	TE Connectivity Ltd. HARD TRAY ASSY FH 0.5BTB CONNECTOR 220POS PLUG 8H WITH GROUND PLATE
		CHK T.FUTATSUGI 26SEP05	
		APVD W.KODAMA 26SEP05	
		PRODUCT SPEC 108-5560	
		APPLICATION SPEC -	NAME
MATERIAL -	FINISH -	WEIGHT -	SIZE A3
		CUSTOMER DRAWING	CAGE CODE 00779
			DRAWING NO C=6318491
			RESTRICTED TO
			SCALE 1:2
			SHEET 3 of 5
			REV D4

4 3 2 1

THIS DRAWING IS UNPUBLISHED. RELEASED FOR PUBLICATION NOV. 1996. ALL RIGHTS RESERVED.

© COPYRIGHT 1996 By -

REVISIONS

P	LTR	DESCRIPTION	DATE	DWN	APVD
-	-	SEE SHEET 1	-	-	-

SECT. Z-Z
(SIGNAL POSITION)

SECT. Y-Y
(GROUND POSITION)

NOTE:

① MATERIAL ; HOUSING : HIGH TEMP THERMO PLASTIC UL94V-0
CONTACT : COPPER ALLOY
SOLDER PEG : COPPER ALLOY

② FINISH ; SIGNAL CONTACT : UNDER PL Ni 0.0013mm MIN ALL OVER.
CONTACT AREA 0.0002mm MIN Au PL.
SOLDERING AREA 0.001mm MIN TIN PL.
GROUND CONTACT : UNDER PL Ni 0.0013mm MIN ALL OVER.
CONTACT AREA 0.0002mm MIN Au PL.
SOLDERING AREA 0.001mm MIN TIN PL.
SOLDER PEG : 0.001mm MIN TIN PL. OVER
0.0013mm MIN Ni PL ALL OVER.

③ THIS POSITION IS GROUND CIRCUIT.

④ THIS PRODUCT WAS COATED BY FLUX-PENETRATION-INHIAITING AGENT.

59.5	57.7	61.8	57.1	54.5	220	BLACK	X-6318491-6
T	S	Q	P	N	POS.	HSG COLOR	PART NO.

THIS DRAWING IS A CONTROLLED DOCUMENT.

DIMENSIONS:
MM

MATERIAL

TOLERANCES UNLESS OTHERWISE SPECIFIED:

0 PLC ± 0.3
1 PLC ± 0.3
2 PLC ± 0.3
3 PLC ± 0.3
4 PLC ± 0.3
ANGLES ± 3'

FINISH

DWN
CHK
APVD
PRODUCT SPEC
APPLICATION SPEC
WEIGHT
CUSTOMER DRAWING

TE TE Connectivity Ltd.

NAME
HARD TRAY ASSY
FH 0.5BTB CONNECTOR 220POS
PLUG 8H WITH GROUND PLATE

SIZE A3 CAGE CODE 00779 DRAWING NO. C=6318491

RESTRICTED TO

SCALE 4:1 SHEET 4 OF 5 REV D4

1470-19 (1/15)

4

3

2

1

THIS DRAWING IS UNPUBLISHED.

RELEASED FOR PUBLICATION

NOV ,1996.

© COPYRIGHT 1996 By -

ALL RIGHTS RESERVED.

REVISIONS

P	LTR	DESCRIPTION	DATE	DWN	APVD
-	-	SEE SHEET 1	-	-	-

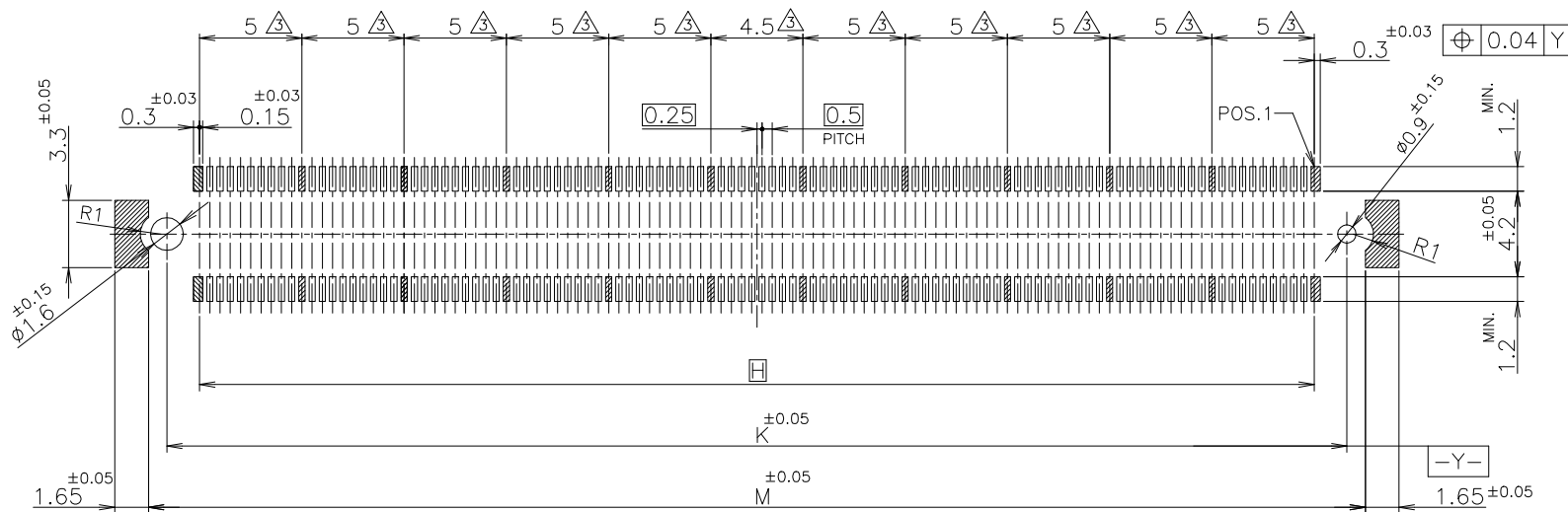

REFERENCE P.C. BOARD LAYOUT

59.5	57.7	54.5	220	X-6318491-6
M	K	H	POS	PART NO.

THIS DRAWING IS A CONTROLLED DOCUMENT.

DIMENSIONS: MM	TOLERANCES UNLESS OTHERWISE SPECIFIED: 0 PLC ± 0.3 1 PLC ± 0.3 2 PLC ± 0.3 3 PLC ± 0.3 4 PLC ± 0.3 ANGLES ± 3'	DWN	TE Connectivity Ltd. NAME HARD TRAY ASSY FH 0.5BTB CONNECTOR 220POS PLUG 8H WITH GROUND PLATE
		CHK	
		APVD	
		PRODUCT SPEC	
MATERIAL	FINISH	APPLICATION SPEC	RESTRICTED TO
		WEIGHT	SIZE CAGE CODE DRAWING NO
		CUSTOMER DRAWING	A3 00779 C=6318491
		SCALE 4:1	SHEET 5 OF 5 REV D4