

## ELUA3535OG5 Series

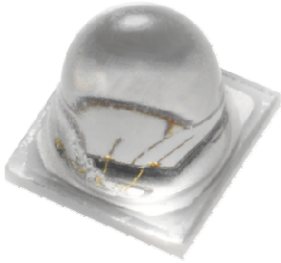

### Introduction

The ELUA3535OG5 product series is a ceramic based LED with high quality and reliability that suitable for UV application.

### Features

- ◆ High power UVA LED
- ◆ Dimension 3.5mm\* 3.5mm\* 3.5mm
- ◆ ESD protection up to 2KV
- ◆ RoHS compliant
- ◆ Pb free
- ◆ EU REACH compliant
- ◆ Halogen Free compliant  
(Br<900ppm,Cl<900ppm,Br+Cl<1500ppm)

### Applications

- ◆ UV Sterilization System
- ◆ UV Photo-catalyst
- ◆ UV Sensor Light

Product Nomenclature

**ELUA3535OG5-PXXXXYY3240500-VD1M**

EL = Everlight

UA = UVA

3535 = 3.5mm x 3.5mm Package

O = Package Material: Al<sub>2</sub>O<sub>3</sub>

G = Coating: Ag

5 = Angle: 50°

P = Peak Wavelength

XXXX = Wavelength Range [1]

YY = Minimum Radiant Flux Spec [2]

3240 = Forward Voltage Spec: 3.2~4.0V

500 = Forward Current: 500mA

V = Chip Type: Vertical

D = Chip Size: 45mil

1 = Chip QTY: 1 chip

M = Process Type: Molding

Notes:

1.Wavelength Range

Symbol	Description
6070	360~370nm
8090	380~390nm
9000	390~400nm
0010	400~410nm

2.Minimum Radiant Flux Spec

Symbol	Description
U1	900mW
U2	1000mW

## Absolute Maximum Ratings

Parameter	Symbol	Ratings	Unit
Max. DC Forward Current (mA) (For 385nm、395nm、405nm)	$I_F$	1000	mA
Max. DC Forward Current (mA) (Only 365nm)	$I_F$	700	mA
Max. ESD Resistance	$V_B$	2000	V
Thermal Resistance	$R_{th}$	4	°C/W
Max. Junction Temperature	$T_J$	105	°C
Operating Temperature	$T_{Opr}$	-10 ~ +100	°C
Storage Temperature	$T_{Stg}$	-40 ~ +100	°C

## PN of the ELUA3535OG5 series: UVA LEDs

Color	Order Code of ELUA3535OG5	Minimum Radiant Flux (mW)	Typical Radiant Flux(mW)	Maximum Radiant Flux(mW)	Peak Wavelength (nm)	Forward Voltage (V)	Forward Current (mA)
Ultraviolet	ELUA3535OG5-P6070U13240500-VD1M	900	1200	1500	360~370	3.2~4.0	500
	ELUA3535OG5-P8090U23240500-VD1M	1000	1250	1500	380~390	3.2~4.0	500
	ELUA3535OG5-P9000U23240500-VD1M	1000	1250	1500	390~400	3.2~4.0	500
	ELUA3535OG5-P0010U23240500-VD1M	1000	1250	1500	400~410	3.2~4.0	500

Product Binning

Radiant Flux Bins

360nm Bin Code	Minimum Radiant Flux (mW)	Maximum Radiant Flux (mW)
U1	900	1100
U2	1100	1300
U3	1300	1500

380~410nm Bin Code	Minimum Radiant Flux (mW)	Maximum Radiant Flux (mW)
U2	1000	1200
U3	1200	1400
U4	1400	1500

Notes:

1. Radiant flux measurement tolerance:  $\pm 10\%$ .
2. Forward voltage bins are defined at  $I_F=500\text{mA}$  operation.

Peak Wavelength Bins

Group	Bin	Minimum Peak Wavelength (nm)	Maximum Peak Wavelength (nm)
U	36	360	370
	38	380	390
	39	390	400
	40	400	410

Notes:

1. Peak Wavelength measurement tolerance:  $\pm 1\text{nm}$ .
2. Forward voltage bins are defined at  $I_F=500\text{mA}$  operation.

Forward Voltage Bins

Bin	Minimum Forward Voltage (V)	Maximum Forward Voltage (V)
3234	3.2	3.4
3436	3.4	3.6
3638	3.6	3.8
3840	3.8	4.0

Notes:

1. Forward voltage measurement tolerance:  $\pm 2\%$ .
2. Forward voltage bins are defined at  $I_F=500\text{mA}$  operation.

Mechanical Dimension

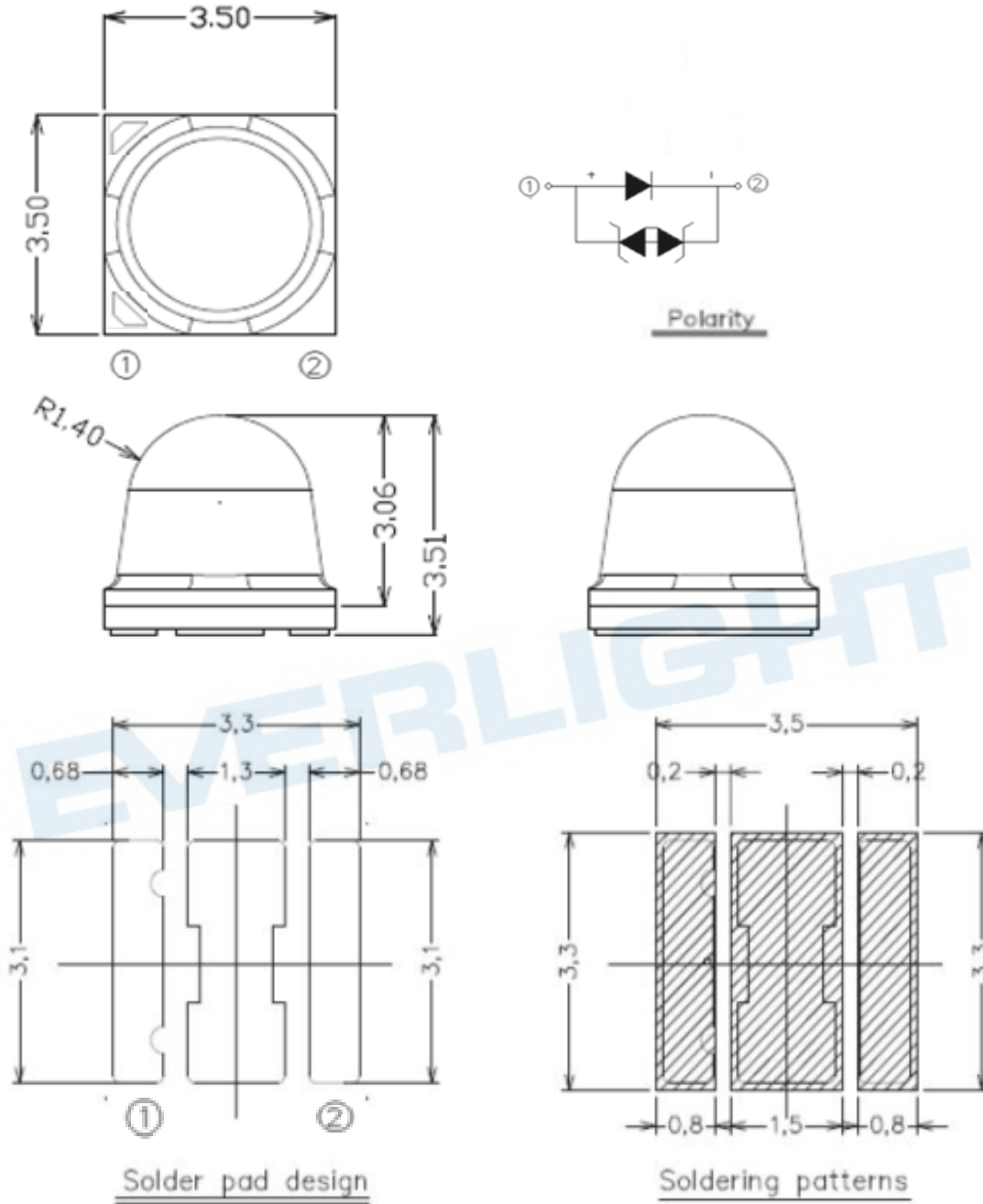

1. Dimensions are in millimeters.
2. Tolerances unless mentioned are  $\pm 0.1\text{mm}$

**Pad Configuration**

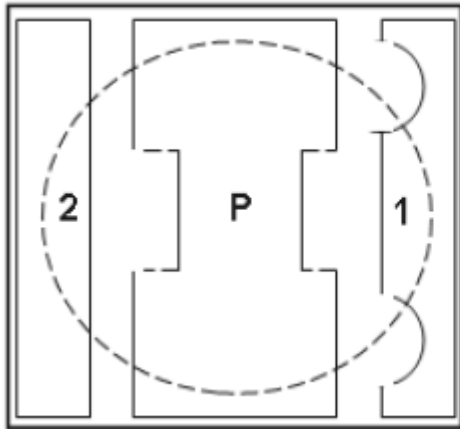

**BOTTOM VIEW**

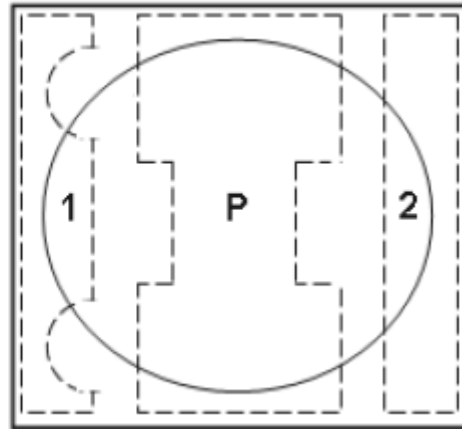

**TOP VIEW**

PAD	FUNCTION
1	ANODE
2	CATHODE
P	THERMAL PAD

## Reflow Soldering Characteristics

### For Reflow Process

- ELUA series are suitable for SMT processes.
- Curing of glue in oven must be according to standard operation flow processes.

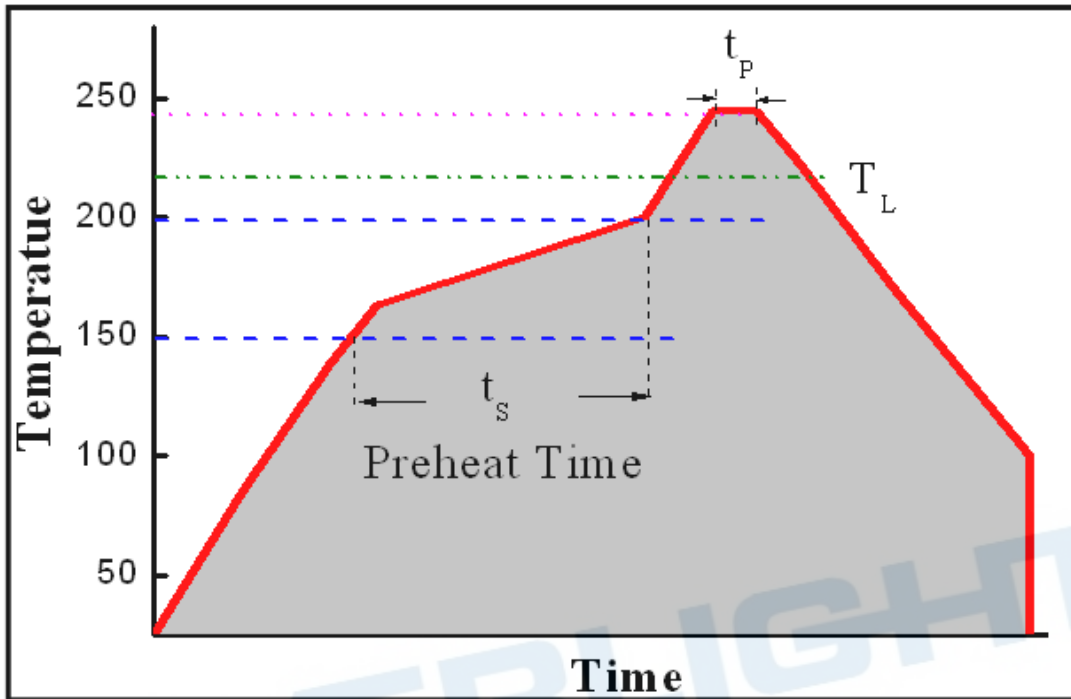

Profile Feature	Lead Free Assembly
Ramp-Up Rate	2-3 °C/S
Preheat Temperature	150-200 °C
Preheat Time ( $t_s$ )	60-120 S
Liquid Temperature ( $T_L$ )	217 °C
Time maintained above $T_L$	60-90 S
Peak Temperature ( $T_P$ )	240±5 °C
Peak Time ( $t_P$ )	Max 20 S
Ramp-Down Rate	3-5 °C/S

- Reflow soldering should not be done more than twice.
- In soldering process, stress on the LEDs during heating should be avoided.
- After soldering, do not bend the circuit board.

Typical Characteristics Curves  
Spectrum @ Thermal Pad Temperature = 25°C

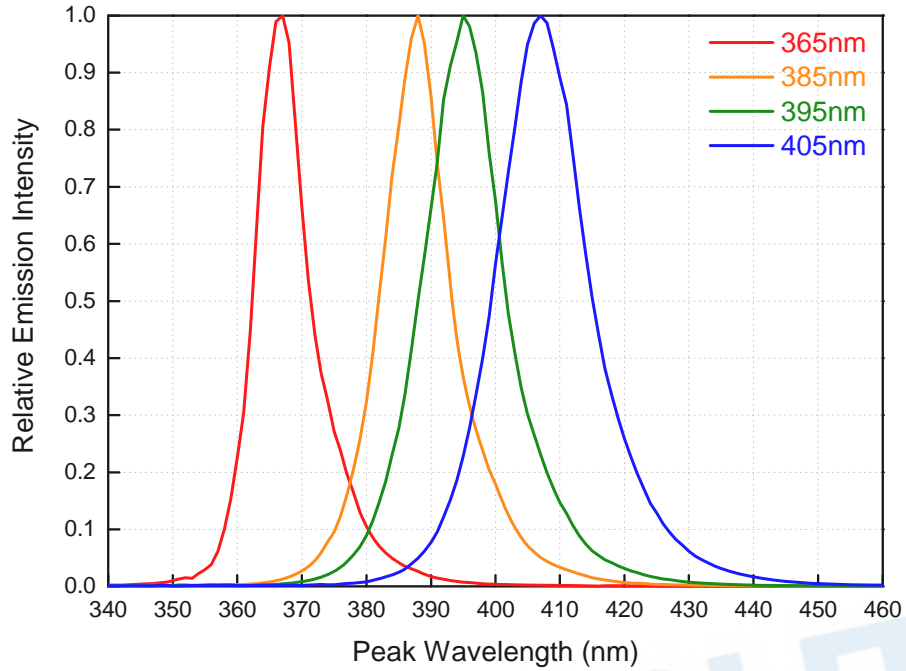

Relative Radiant Flux vs. Forward Current  
@ Thermal Pad Temperature = 25°C

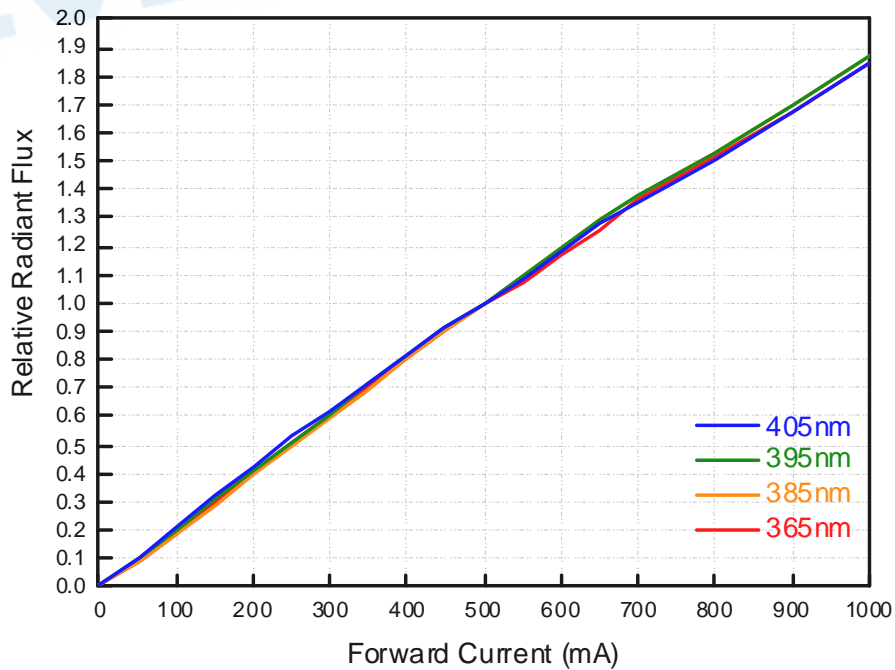

**Peak Wavelength vs. Forward Current**  
@ Thermal Pad Temperature = 25°C

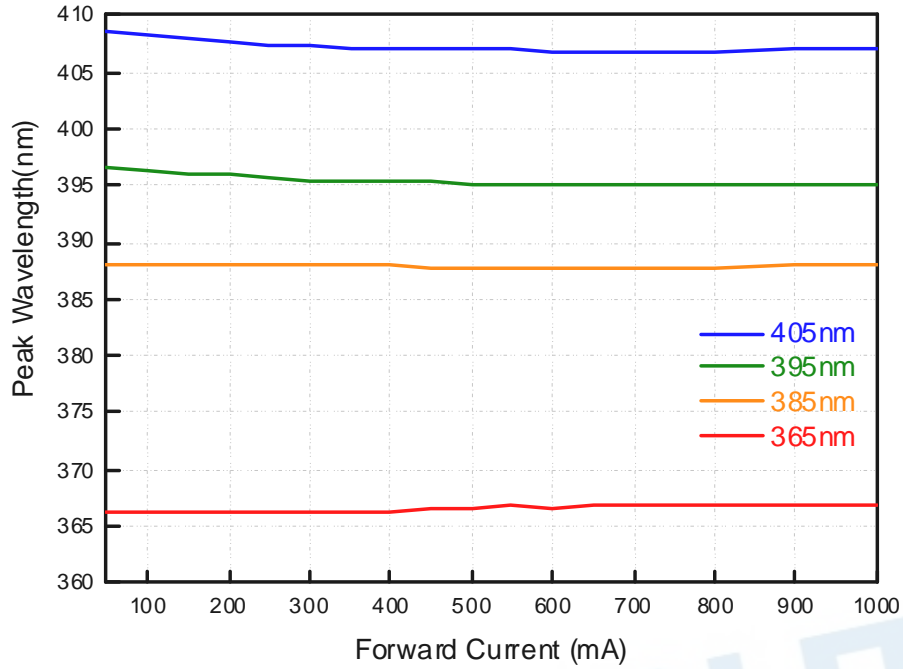

**Forward Voltage vs. Forward Current**  
@ Thermal Pad Temperature = 25°C

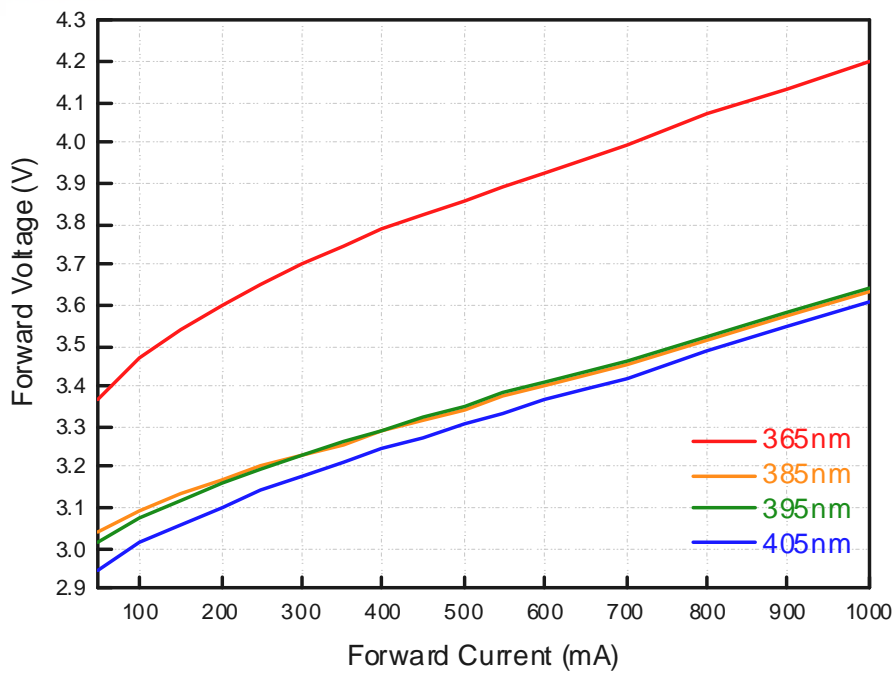

**Relative Radiant Flux vs. Ambient Temperature**  
@ Forward Current = 500mA

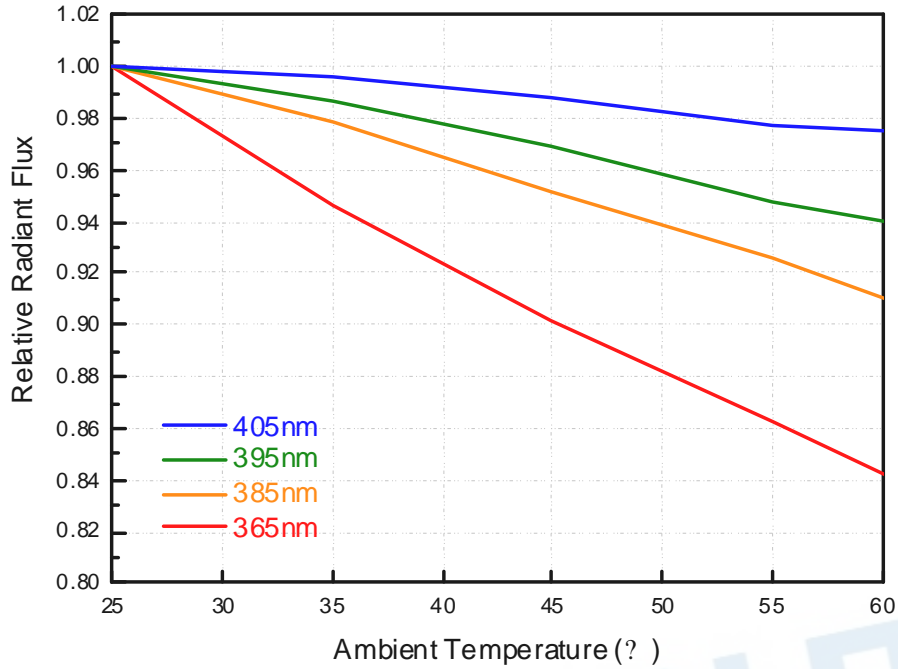

**Peak Wavelength vs. Ambient Temperature**  
@ Forward Current = 500mA

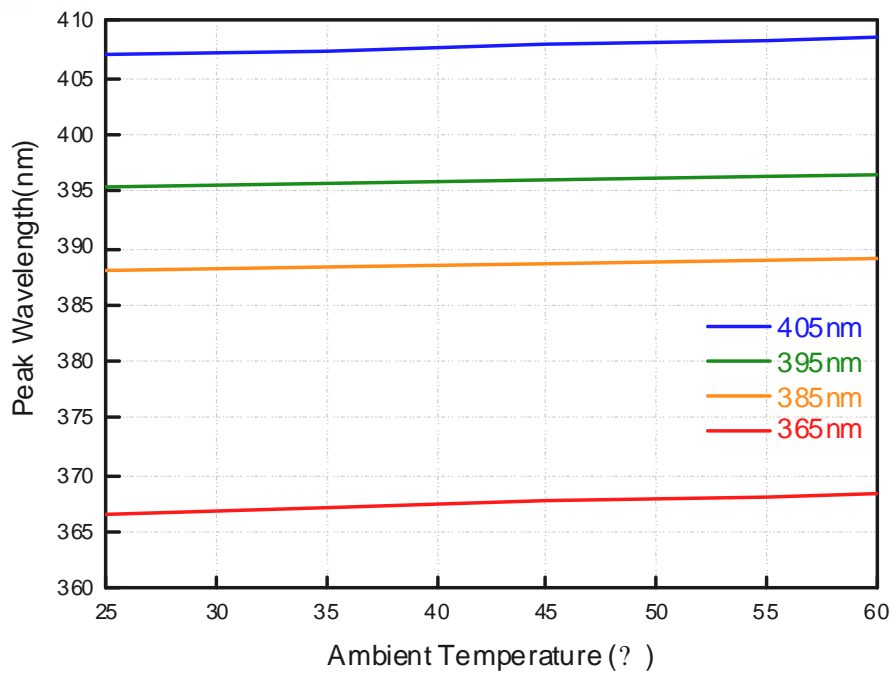

### Forward Voltage vs. Ambient Temperature @ Forward Current = 500mA

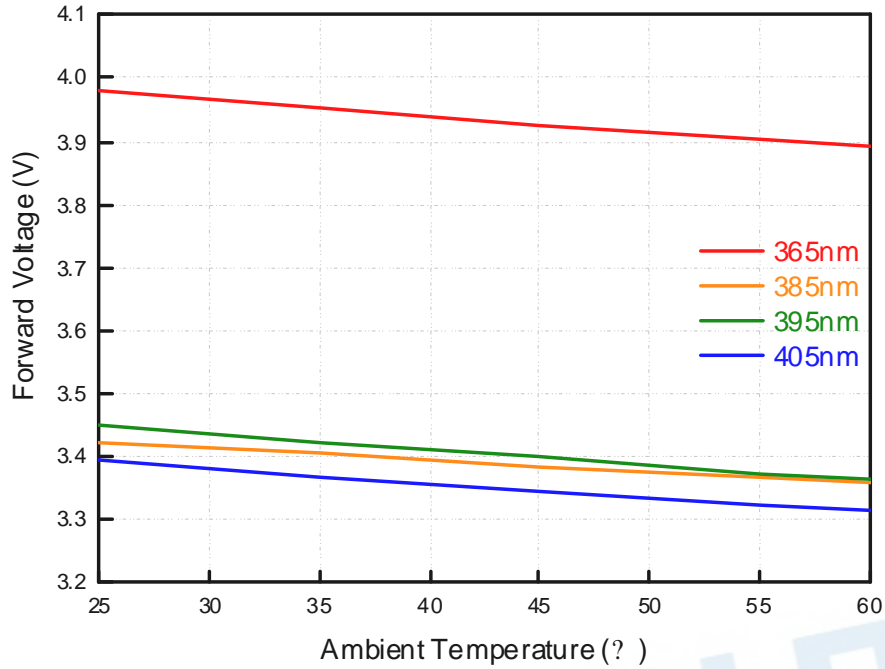

### Derating Curve

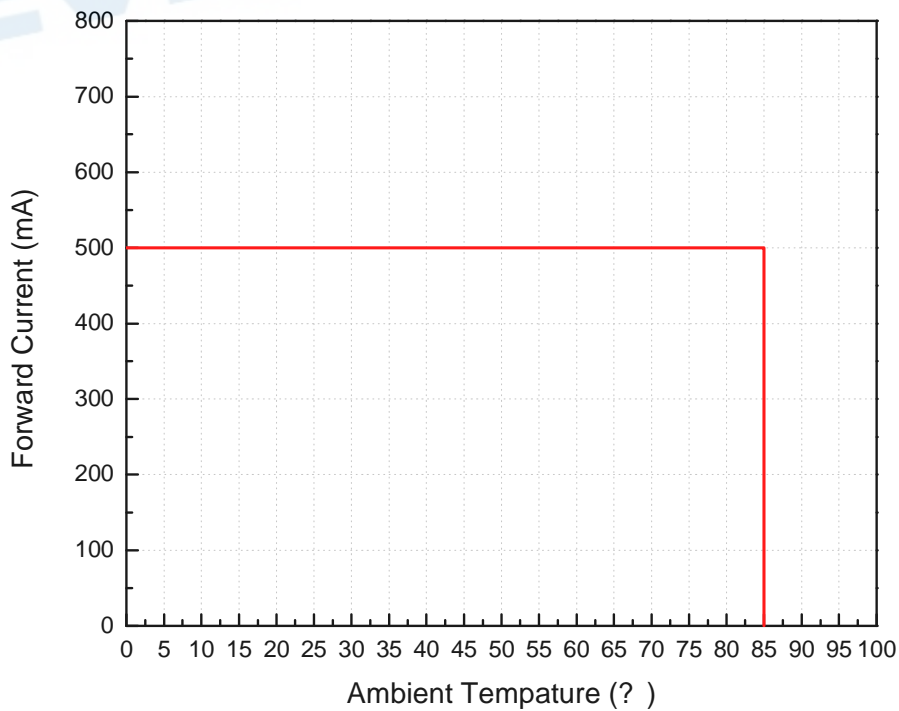

### Typical Radiation Patterns Typical Diagram Characteristics of Radiation for ELUA3535OG5

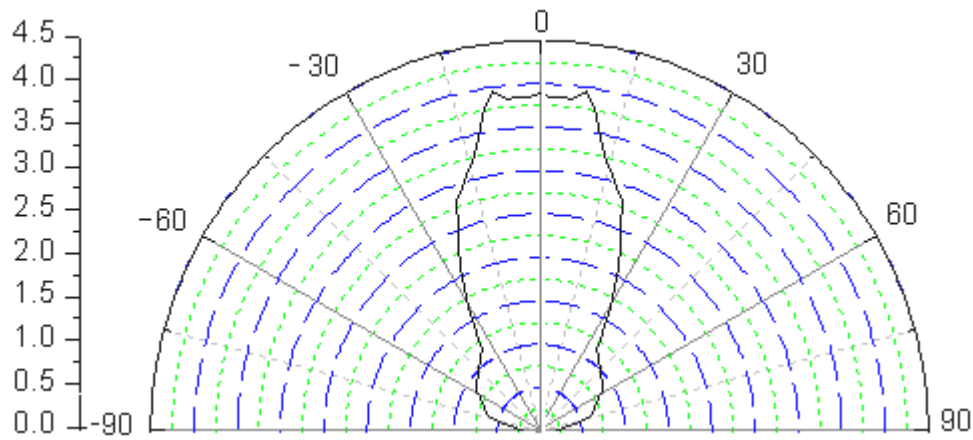

**Notes:**

1.  $2\theta_{1/2}$  is the off axis angle from lamp centerline where the luminous intensity is 1/2 of the peak value.
2. View angle tolerance is  $\pm 5^\circ$  .

EVERLIGHT

**Emitter Tape Packaging**  
Carrier Tape Dimensions as the following:

Reel: 400pcs

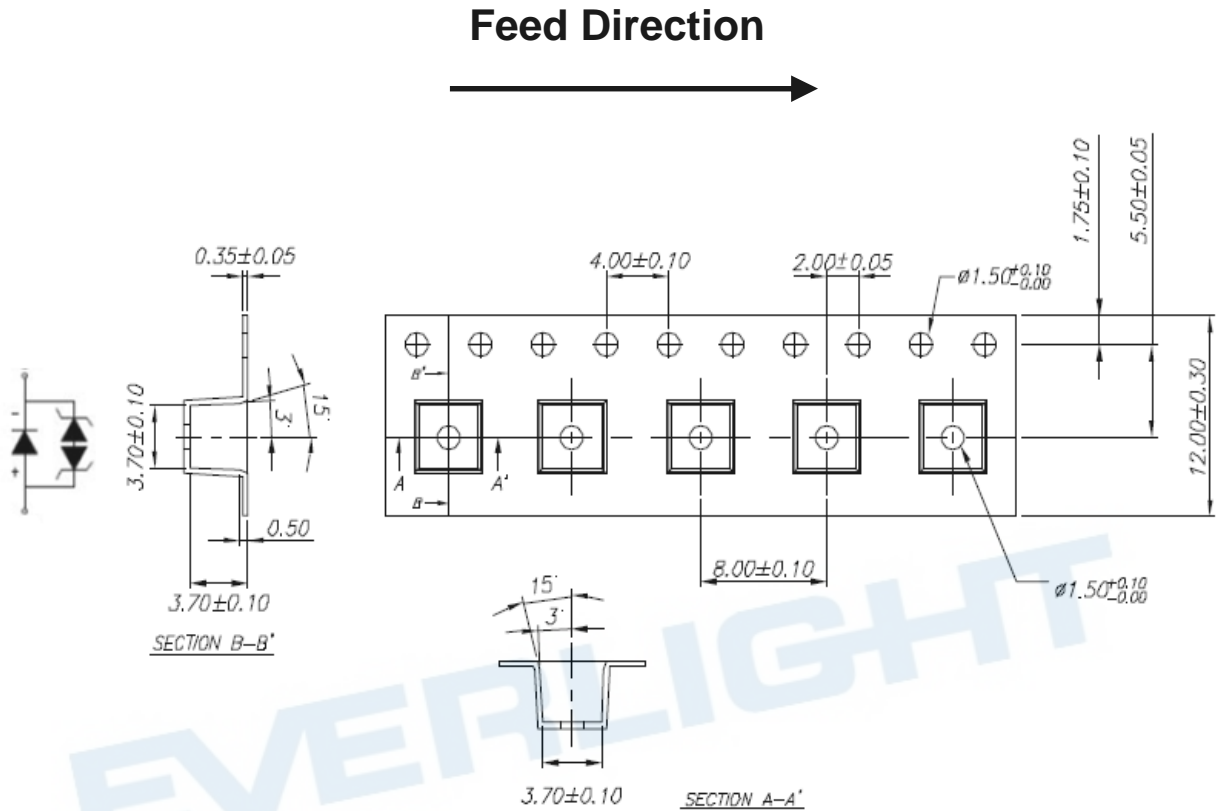

**Notes:**

1. Tolerance unless mentioned is  $\pm 0.1$ mm; Unit = mm
2. Packing amount is 100/200/300/400 pcs per reel

**Moisture Resistant Packaging**

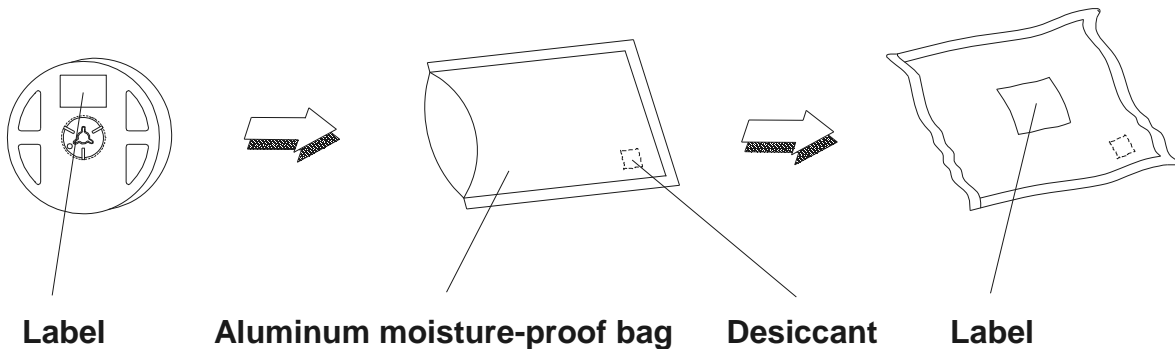

Emitter Reel Packaging

Reel Dimensions

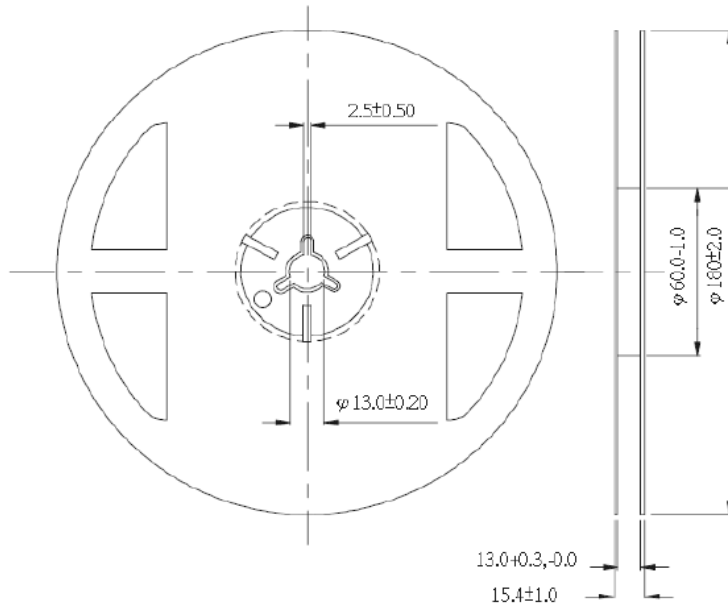

Notes:

1. Dimensions are in millimeters.
2. Tolerances unless mentioned are ±0.1mm.

Product Labeling  
Label Explanation

CPN: Customer Specification (when required)

P/N : Everlight Production Number

QTY: Packing Quantity

CAT: Luminous Flux (Brightness) Bin

HUE: Color Bin

REF: Forward Voltage Bin

LOT No: Lot Number

MADE IN TAIWAN: Production Place

RoHS		EVERLIGHT	5
CPN: XXXXXXXXXXXXXXXXXXXX			
XXXXXXXXXX-XXXXXXXXXX-XXXXXXXXXX-XXXXXXXXXX-XXXXXX			
P/N: XXXXXXXXXXXXX			
XXXXXXXXXX-XXXXXXXXXX-XXXXXXXXXX-XXXXXXXXXX-XXXXXX			
LOT NO: Y150716XXX-XXXXXXXXXX-XXXXXXXXXX			
QTY: 0123456789 HUE: XXXXXXXXXXXX			
CAT: XXXXXXXXXXXX REF: XXXXXXXXXXXX			
REFERENCE: BTPYYMDDXXXXX			
MSL-X MADE IN XXXXXX			



## Storage Conditions

- Before the package is opened. The LEDs should be stored at 30°C or less and 90%RH or less after being shipped from EVERLIGHT and the storage life limits are 12 months.
- After opening the package: The LED's floor life is unlimited under 30°C or less and 85% RH or less. If unused LEDs remain, it should be stored in moisture proof packages.
- If the moisture absorbent material (silica gel) has faded away or the LEDs have exceeded the storage time, baking treatment should be performed using the following conditions. Baking treatment: 60±5°C for 24 hours.

## DISCLAIMER

- EVERLIGHT reserves the right(s) on the adjustment of product material mix for the specification.
- The product meets EVERLIGHT published specification for a period of twelve (12) months from date of shipment.
- The graphs shown in this datasheet are representing typical data only and do not show guaranteed values.
- When using this product, please observe the absolute maximum ratings and the instructions for using outlined in these specification sheets. EVERLIGHT assumes no responsibility for any damage resulting from the use of the product which does not comply with the absolute maximum ratings and the instructions included in these specification sheets.
- These specification sheets include materials protected under copyright of EVERLIGHT. Reproduction in any form is prohibited without obtaining EVERLIGHT's prior consent.
- This product is not intended to be used for military, aircraft, automotive, medical, life sustaining or life saving applications or any other application which can result in human injury or death. Please contact authorized EVERLIGHT sales agent for special application request.
- **The product is not suitable for use in an ammonia environment.**