

I

CHAPTER

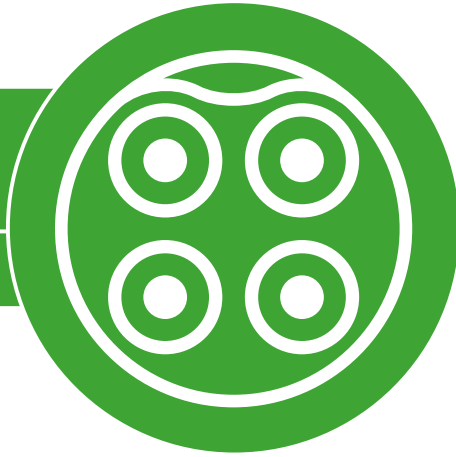

FISCHER FIBEROPTIC SERIES

ROBUST | OPTICAL PERFORMANCE | EASY CLEANING

KEY FEATURES

- Faultless optical performance
- Indoor, outdoor and extreme applications
- Up to IP67 (unmated) / IP68 (mated)
- Easy field cleaning



FIBEROPTIC

FIBEROPTIC



PLUGS



CABLE MOUNTED

- Body styles (P01) I-4
- Technical dimensions I-5

RECEPTACLES



CABLE MOUNTED

- Body styles (R50) I-8
- Technical dimensions I-9



PANEL REAR MOUNTED

- Body styles (R01) I-12
- Technical dimensions I-13



PANEL FRONT MOUNTED

- Body styles (R03; R13) I-12
- Technical dimensions I-16

FOR ALL FIBEROPTIC

- Configuration matrix I-3
- Wire and fiber termination I-22
- Part numbering I-23
- Protective caps I-25
- Deployment accessories I-26
- Accessories I-28
- Technical information I-29
- Quote request form I-31

This catalog covers our standard connector solutions. For specific requests, including hybrid or custom connectors, please contact your local sales representative.

PLUGS & RECEPTACLES

Wire set	P01	R01	R03	R13	R50
FO1		●	●	●	
FO2		●	●	●	
FO4		●	●	●	
FOH		●	●	●	

Cable Clamp set	P01	R01	R03	R13	R50
FO1	●	●	●	-	●
FO2	●	●	●	●	●
FO4	●	●	●	●	●
FOH					

Potting set	P01	R01	R03	R13	R50
FO1	●	●	●	-	●
FO2	●	●	●	●	●
FO4	●	●	●	●	●
FOH	●	●	●	●	●

FIBEROPTIC

PLUGS

CABLE MOUNTED



FIBEROPTIC

Body style		P01	References to detailed information
Protection	Unsealed (IP50)		Sealing categories, page A-6
	Sealed up to IP68	●	
Locking system	Friction		Locking systems, page A-5
	Push-pull	●	
	Quick-release		
	Lanyard		
	Tamperproof		
Termination	Fiber optic termini	●	Fiber type and pin layout, page I-30
	Electrical solder contacts ¹⁾	●	
Housing color	Natural chrome	●	Technical information, page I-29
Design	Shortened body		
	Straight	●	
	Right-angle		
Rear Accessories ²⁾	Wire sets		Rear Accessories, pages I-5 to I-7
	Cable clamp set	●	
	Potting set	●	
Accessories	Cable bend reliefs		Accessories, page I-25
	Protective sleeves		
	Soft caps	●	
Size	FO1	●	Technical dimensions, pages I-5 to I-7 For more information visit our website www.fischerconnectors.com/technical
	FO2/FO4	●	
	FOH	●	

¹⁾ FOH only.

²⁾ Please refer to configurations matrix on page I-3.

PLUGS - FO1

CABLE MOUNTED

P01

BODY STYLE

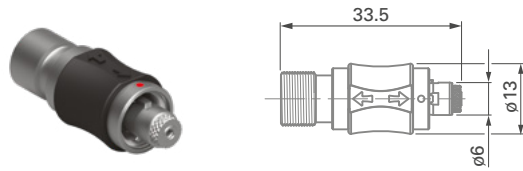

Part number	Description
FO1 P01LGR1 00A00 A 000	FO1 - P01 Plug
FO1 P01 CABLE CLAMP SET L36 D3.5 ¹⁾	FO1 - P01 Plug cable clamp set
FO1 P01 POTTING SET L41 D3.5 ¹⁾	FO1 - P01 Plug potting set

REAR ACCESSORIES

CABLE CLAMP SET

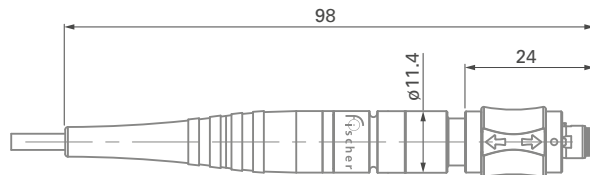

POTTING SET

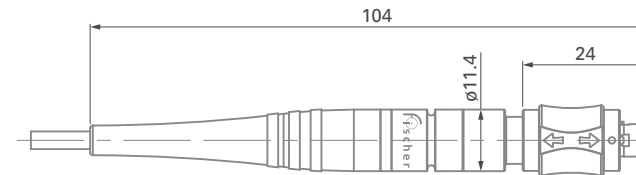

¹⁾ The last number indicates the max compatible cable diameter in mm.
 Note: indicated connector P/N = delivered without contact, termini and rear accessory

PLUGS - FO2/FO4

CABLE MOUNTED

P01

BODY STYLE

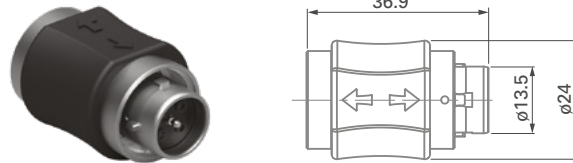

Part number	Description
FO2 P01LGR1 00A00 A 000	FO2 - P01 Plug
FO4 P01LGR1 00A00 A 000	FO4 - P01 Plug
FO2-4 P01 CABLE CLAMP SET L49 D6 ¹⁾	FO2/FO4 - P01 Plug cable clamp set
FO2-4 P01 POTTING SET L49 D6.5 ¹⁾	FO2/FO4 - P01 Plug potting set

REAR ACCESSORIES

CABLE CLAMP SET

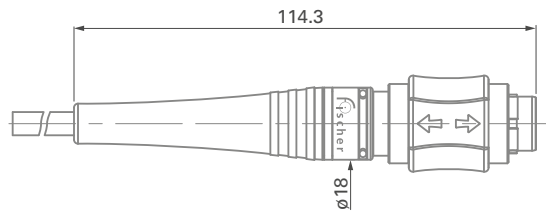

POTTING SET

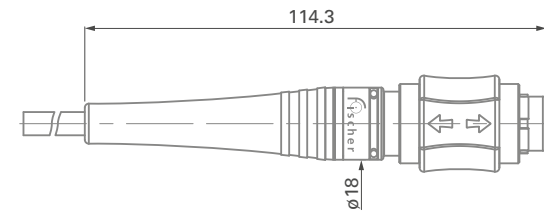

¹⁾ The last number indicates the max compatible cable diameter in mm.
 Note: indicated connector P/N = delivered without contacts, termini and rear accessory

PLUGS - FOH

CABLE MOUNTED

P01

BODY STYLE

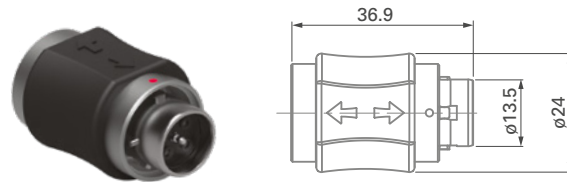

Part number	Description
FOH P01LGR1 00A00 A 000	FOH - P01 Plug
FOH P01 POTTING SET L54 D10.8 ¹⁾	FOH - P01 Plug potting set

REAR ACCESSORIES

POTTING SET

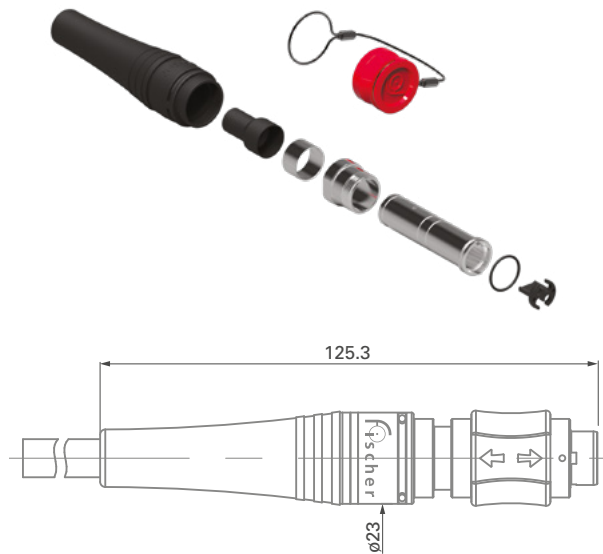

¹⁾ The last number indicates the max compatible cable diameter in mm.
 Note: indicated connector P/N = delivered without contacts, termini and rear accessory

All dimensions and images shown are in millimeters and are for reference only.

RECEPTACLES

CABLE MOUNTED



Body style		R50	References to detailed information
Protection	Unsealed (IP50)		Sealing categories, page A-6
	Sealed up to IP68	●	
Locking system	Friction		Locking systems, page A-5
	Push-pull	●	
	Quick-release		
	Lanyard		
	Tamperproof		
Termination	Fiber optic termini	●	Fiber type and pin layout, page I-30
	Electrical solder contacts ¹⁾	●	
Housing color	Natural chrome	●	Technical information, page I-29
Design	Shortened body		
	Straight	●	
	Right-angle		
Rear Accessories ¹⁾	Wire sets		Rear accessories, pages I-9 to I-11
	Cable clamp set	●	
	Potting set	●	
Accessories	Cable bend reliefs		Accessories, page I-25
	Protective sleeves		
	Soft caps	●	
Size	FO1	●	Technical dimensions, page I-9 to I-11 For more information visit our website www.fischerconnectors.com/technical
	FO2/FO4	●	
	FOH	●	

¹⁾ Please refer to configurations matrix on page I-3.

RECEPTACLES - FO1

CABLE MOUNTED

R50

BODY STYLE

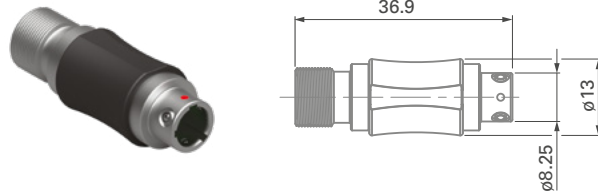

Part number	Description
FO1 R50LGR1 00A00 A 000	FO1 - R50 Receptacle
FO1 R50 CABLE CLAMP SET L36 D3.5 ¹⁾	FO1 - R50 Receptacle cable clamp set
FO1 R50 POTTING SET L41 D3.5 ¹⁾	FO1 - R50 Receptacle potting set

REAR ACCESSORIES

CABLE CLAMP SET

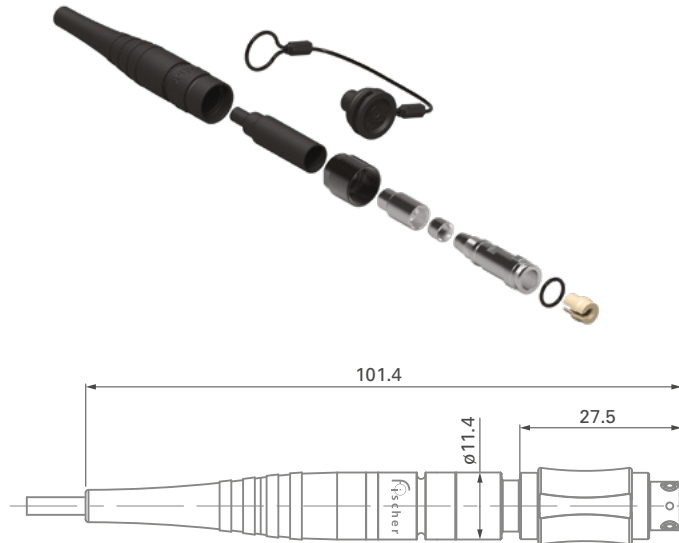

POTTING SET

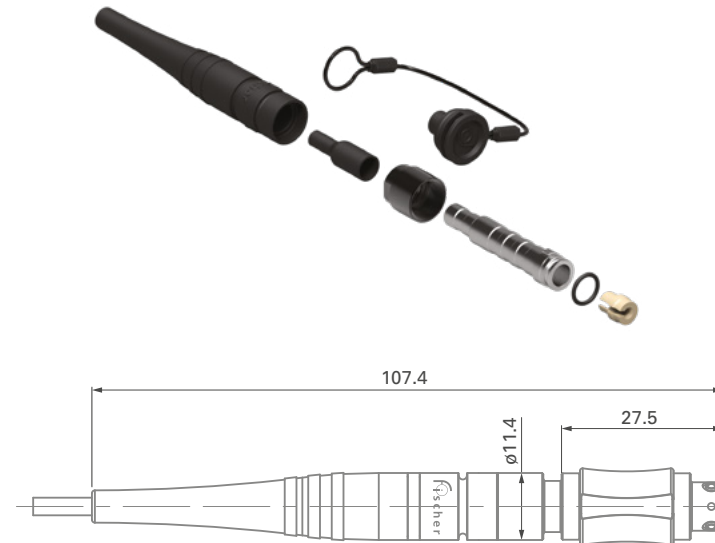

¹⁾ The last number indicates the max compatible cable diameter in mm.
 Note: indicated connector P/N = delivered without contact, termini and rear accessory

RECEPTACLES - FO2/FO4

CABLE MOUNTED

R50

BODY STYLE

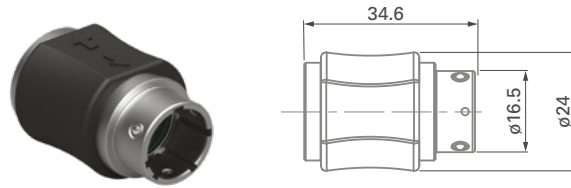

Part number	Description
FO2 R50LGR1 00A00 A 000	FO2 - R50 Receptacle
FO4 R50LGR1 00A00 A 000	FO4 - R50 Receptacle
FO2-4 R50 CABLE CLAMP SET L49 D6 ¹⁾	FO2/FO4 - R50 Plug cable clamp set
FO2-4 R50 POTTING SET L49 D6.5 ¹⁾	FO2/FO4 - R50 Plug potting set

REAR ACCESSORIES

CABLE CLAMP SET

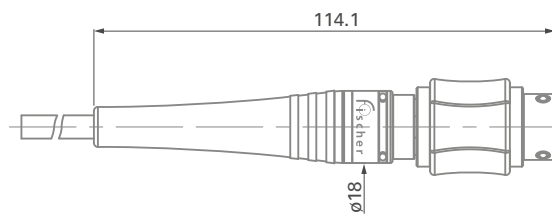

POTTING SET

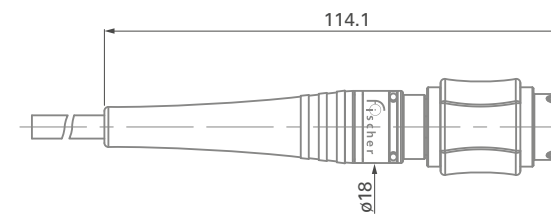

¹⁾ The last number indicates the max compatible cable diameter in mm.
 Note: indicated connector P/N = delivered without contacts, termini and rear accessory

RECEPTACLES - FOH

CABLE MOUNTED

R50

BODY STYLE

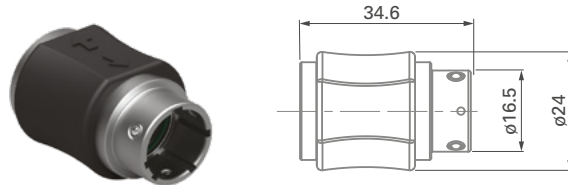

Part number	Description
FOH R50LGR1 00A00 A 000	FOH - R50 Receptacle
FOH R50 POTTING SET L54 D10.8 ¹⁾	FOH - R50 Receptacle potting set

POTTING SET

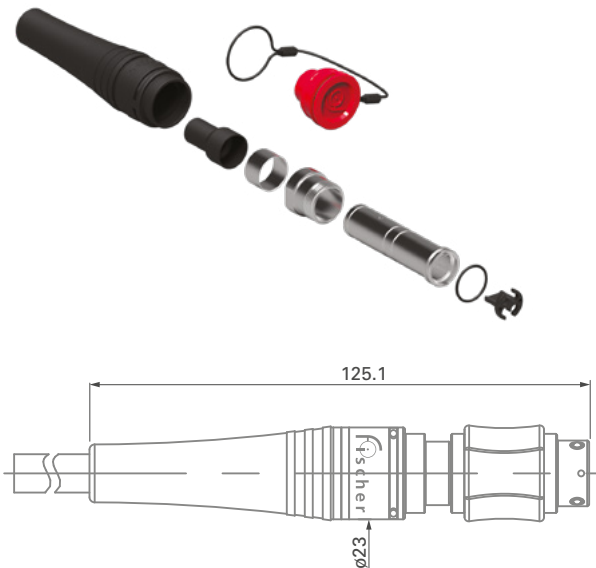

¹⁾ The last number indicates the max compatible cable diameter in mm.

Note: indicated connector P/N = delivered without contact, termini and rear accessory

All dimensions and images shown are in millimeters and are for reference only.

RECEPTACLES

PANEL MOUNTED



FIBEROPTIC

Body style		R01	R03	R13	References to detailed information
Protection	Unsealed (IP50)				Sealing categories, page A-6
	Sealed up to IP68	●	●	●	
Locking system	Friction				Locking systems, page A-5
	Push-pull	●	●	●	
	Quick-release				
	Lanyard				
	Tamperproof				
Termination	Fiber optic termini	●	●	●	Fiber type and pin layout, page I-30
	Electrical solder contacts ¹⁾	●	●	●	
Housing color	Natural chrome	●	●	●	Technical information, page I-29
Design	Shortened body				
	Straight	●	●	●	
	Right-angle				
Rear Accessories ¹⁾	Wire sets	●	●	●	Pages I-13 to I-21
	Cable clamp set	●	●	●	
	Potting set	●	●	●	
Accessories	Cable bend reliefs				Accessories, section I-25
	Protective sleeves				
	Soft caps	●	●	●	
Size	FO1	●	●	●	Technical dimensions, page I-13 to I-21 For more information visit our website www.fischerconnectors.com/technical
	FO2/FO4	●	●	●	
	FOH	●	●	●	

¹⁾ Please refer to configurations matrix on page I-3.

RECEPTACLES - FO1

PANEL REAR MOUNTED

R01

BODY STYLE

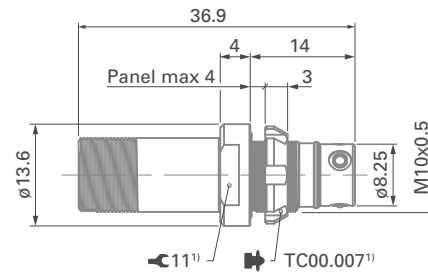

Part number	Description
FO1 R01LGR1 00A00 A 000	FO1 - R01 Receptacle
FO1 R01 WIRE SET L18 D3.5	FO1 - R01 Receptacle wire set
FO1 R01 CABLE CLAMP SET L36 D3.5 ²⁾	FO1 - R01 Receptacle cable clamp set
FO1 R01 POTTING SET L41 D3.5 ²⁾	FO1 - R01 Receptacle potting set

REAR ACCESSORIES

WIRE SET



CABLE CLAMP SET

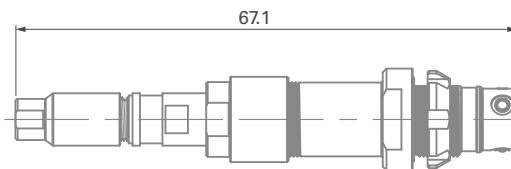

POTTING SET

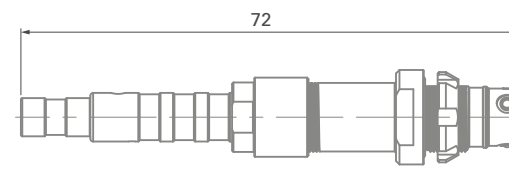

PANEL CUT-OUT

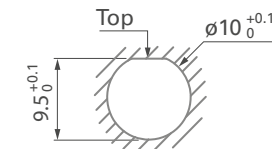

¹⁾ Torque 5.0 Nm. Torque (Nm) are recommended values that may be influenced by the quality of the panel surface. Tests have to be made to evaluate the exact values.

²⁾ The last number indicates the max compatible cable diameter in mm.

Note: indicated connector P/N = delivered without contact, termini and rear accessory

All dimensions and images shown are in millimeters and are for reference only.

RECEPTACLES - FO2/FO4

PANEL REAR MOUNTED

R01

BODY STYLE

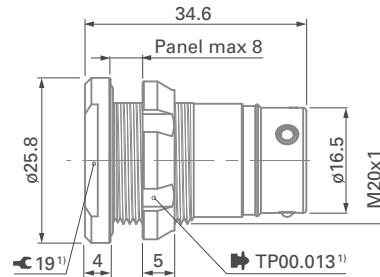

Part number	Description
FO2 R01LGR1 00A00 A 000	FO2/FO4 - R01 Receptacle
FO4 R01LGR1 00A00 A 000	FO2/FO4 - R01 Receptacle
FO2 R01 WIRE SET L20 D6.5	FO2 - R01 Receptacle wire set
FO4 R01 WIRE SET L20 D6.5	FO4 - R01 Receptacle wire set
FO2-4 R01 CABLE CLAMP SET L49 D6.5 ²⁾	FO2/FO4 - R01 Receptacle cable clamp set
FO2-4 R01 POTTING SET L49 D6.5 ²⁾	FO2/FO4 - R01 Receptacle potting set

REAR ACCESSORIES

WIRE SET

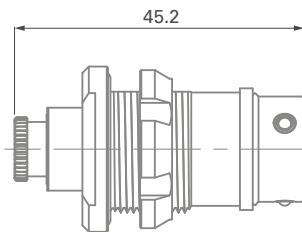

CABLE CLAMP SET

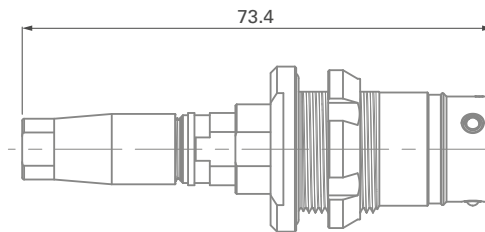

POTTING SET

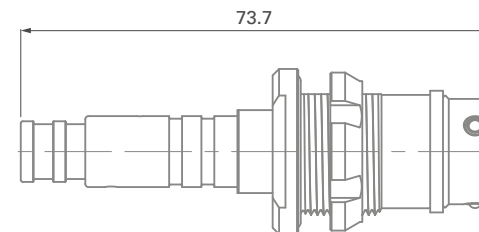

PANEL CUT-OUT

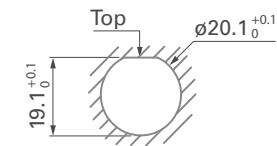

¹⁾ Torque 6.5 Nm. Torque (Nm) are recommended values that may be influenced by the quality of the panel surface. Tests have to be made to evaluate the exact values.

²⁾ The last number indicates the max compatible cable diameter in mm.

Note: indicated connector P/N = delivered without contacts, termini and rear accessory

RECEPTACLES - FOH

PANEL REAR MOUNTED

R01

BODY STYLE

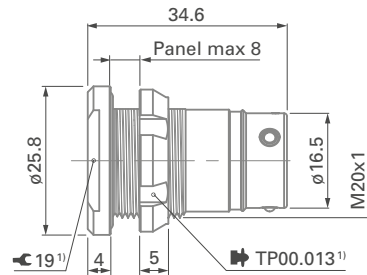

Part number	Description
FOH R01LGR1 00A00 A 000	FOH - R01 Receptacle
FOH R01 WIRE SET L26 D8	FOH - R01 Receptacle wire set
FOH R01 POTTING SET L54 D10.8 ²⁾	FOH - R01 Receptacle potting set

REAR ACCESSORIES

WIRE SET

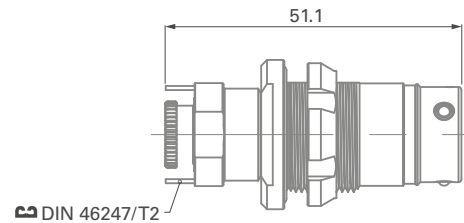

POTTING SET

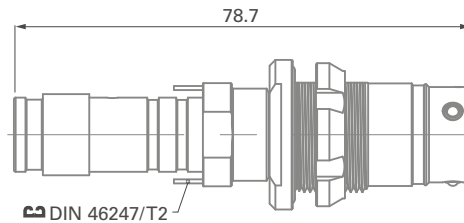

PANEL CUT-OUT

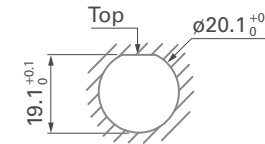

¹⁾ Torque 6.5 Nm. Torque (Nm) are recommended values that may be influenced by the quality of the panel surface. Tests have to be made to evaluate the exact values.

²⁾ The last number indicates the max compatible cable diameter in mm.

Note: indicated connector P/N = delivered without contacts, termini and rear accessory

All dimensions and images shown are in millimeters and are for reference only.

RECEPTACLES - FO1

PANEL FRONT MOUNTED

R03

BODY STYLE

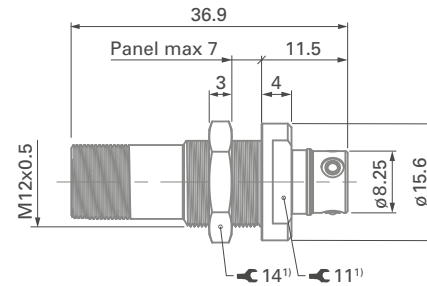

Part number	Description
FO1 R03LGR1 00A00 A 000	FO1 - R03 Receptacle
FO1 R03 WIRE SET L18 D3.5	FO1 - R03 Receptacle wire set
FO1 R03 CABLE CLAMP SET L36 D3.5 ²⁾	FO1 - R03 Receptacle cable clamp set
FO1 R03 POTTING SET L41 D3.5 ²⁾	FO1 - R03 Receptacle potting set

REAR ACCESSORIES

WIRE SET

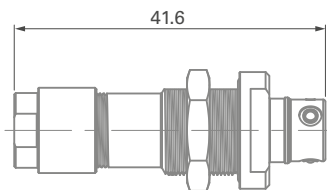

CABLE CLAMP SET

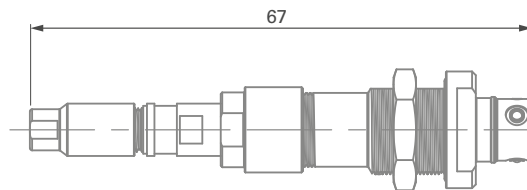

POTTING SET

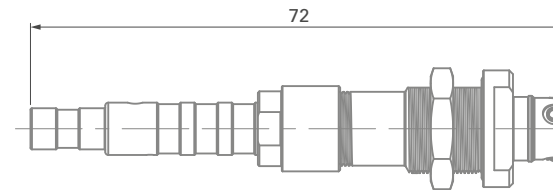

PANEL CUT-OUT

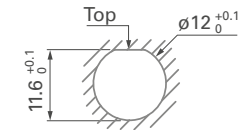

¹⁾ Torque 5.0 Nm. Torque (Nm) are recommended values that may be influenced by the quality of the panel surface. Tests have to be made to evaluate the exact values.

²⁾ The last number indicates the max compatible cable diameter in mm.

Note: indicated connector P/N = delivered without contact, termini and rear accessory

RECEPTACLES - FO2/FO4

PANEL FRONT MOUNTED

R03

BODY STYLE

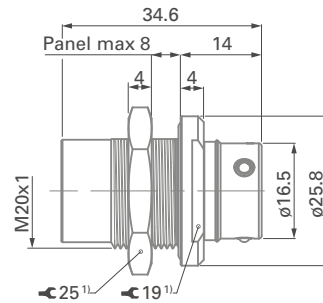

Part number	Description
FO2 R03LGR1 00A00 A 000	FO2 - R03 Receptacle
FO4 R03LGR1 00A00 A 000	FO4 - R03 Receptacle
FO2 R03-R13 WIRE SET L20 D6.5	FO2 - R03 Receptacle wire set
FO4 R03-R13 WIRE SET L20 D6.5	FO4 - R03 Receptacle wire set
FO2-4 R03-R13 CABLE CLAMP SET L49 D6.5 ²⁾	FO2/FO4 - R03 Receptacle cable clamp set
FO2-4 R03-R13 POTTING SET L49 D6.5 ²⁾	FO2/FO4 - R03 Receptacle potting set

REAR ACCESSORIES

WIRE SET

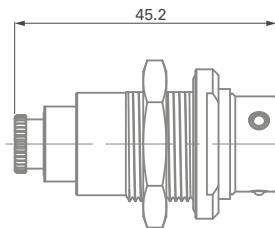

CABLE CLAMP SET

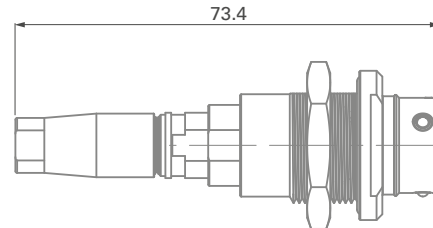

POTTING SET

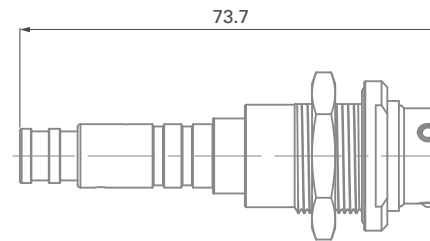

PANEL CUT-OUT

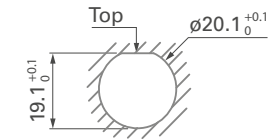

¹⁾ Torque 6.5 Nm. Torque (Nm) are recommended values that may be influenced by the quality of the panel surface. Tests have to be made to evaluate the exact values.

²⁾ The last number indicates the max compatible cable diameter in mm.

Note: indicated connector P/N = delivered without contacts, termini and rear accessory

All dimensions and images shown are in millimeters and are for reference only.

RECEPTACLES - FOH

PANEL FRONT MOUNTED

R03

BODY STYLE

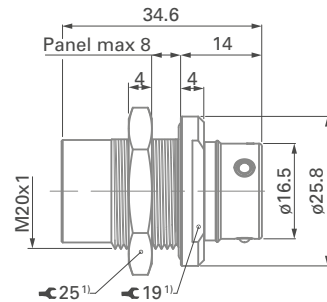

Part number	Description
FOH R03LGR1 00A00 A 000	FOH - R03 Receptacle
FOH R03-R13 WIRE SET L26 D8	FOH - R03-R13 Receptacle wire set
FOH R03-R13 CABLE CLAMP SET L54 D10.8 ²⁾	FOH - R03-R13 Receptacle cable clamp set
FOH R03 POTTING SET L41 D3.5 ²⁾	FOH - R03 Receptacle potting set

REAR ACCESSORIES

WIRE SET

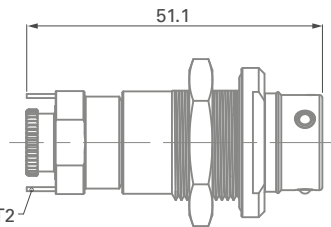

POTTING SET

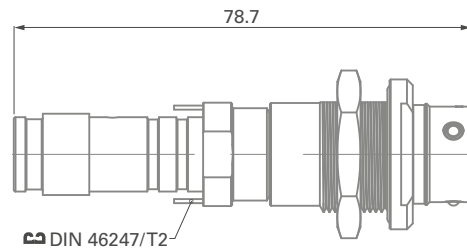

PANEL CUT-OUT

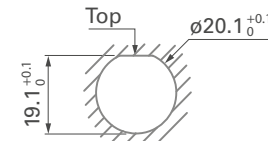

¹⁾ Torque 6.5 Nm. Torque (Nm) are recommended values that may be influenced by the quality of the panel surface. Tests have to be made to evaluate the exact values.

²⁾ The last number indicates the max compatible cable diameter in mm.

Note: indicated connector P/N = delivered without contacts, termini and rear accessory

RECEPTACLES - FO1

PANEL FRONT MOUNTED

R13 - SQUARE FLANGE¹⁾

BODY STYLE

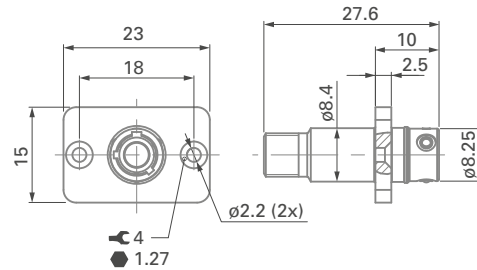

Part number	Description
FO1 R13LGR1 00A00 A 000	FO1 - R13 Receptacle
FO1 R13 WIRE SET L20 D3.5	FO1 - R13 Receptacle wire set

REAR ACCESSORY

WIRE SET

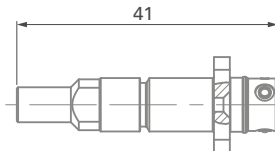

PANEL CUT-OUT

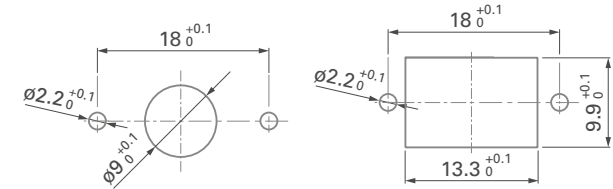

Compatible with above SC & LC duplex panel cut-out

¹⁾ Due to panel mounting with screws, sealing can't be guaranteed at panel level.
Note: indicated connector P/N = delivered without contact, termini and rear accessory

RECEPTACLES - FO2/FO4

PANEL FRONT MOUNTED

R13 - SQUARE FLANGE¹⁾

BODY STYLE

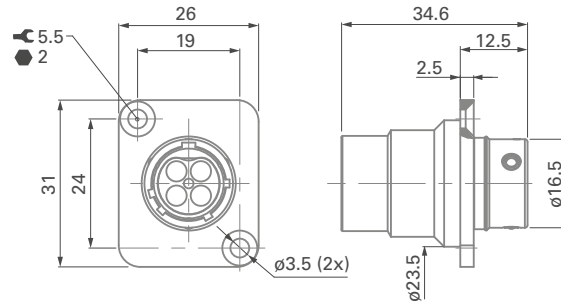

Part number	Description
FO2 R13LGR1 00A00 A 000	FO2 - R13 Receptacle
FO4 R13LGR1 00A00 A 000	FO4 - R13 Receptacle
FO2 R03-R13 WIRE SET L20 D6.5	FO2 - R03-R13 Receptacle wire set
FO4 R03-R13 WIRE SET L20 D6.5	FO4 - R03-R13 Receptacle wire set
FO2-4 R03-R13 CABLE CLAMP SET L49 D6 ²⁾	FO2/FO4 - R03-R13 Receptacle cable clamp set
FO2-4 R03-R13 POTTING SET L49 D6.5 ²⁾	FO2/FO4 - R03-R13 Receptacle potting set

REAR ACCESSORIES

WIRE SET

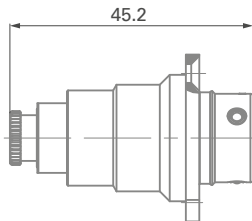

CABLE CLAMP SET

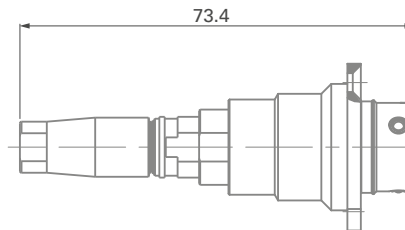

POTTING SET

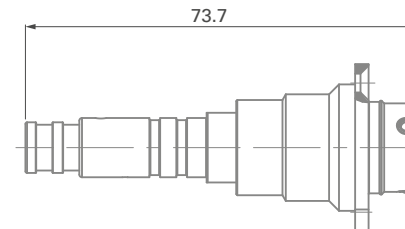

PANEL CUT-OUT

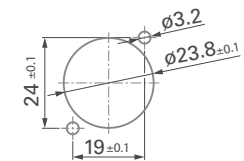

¹⁾ Due to panel mounting with screws, sealing can't be guaranteed at panel level.

²⁾ The last number indicates the max compatible cable diameter in mm.

Note: indicated connector P/N = delivered without contacts, termini and rear accessory

RECEPTACLES - FOH

PANEL FRONT MOUNTED

R13 - SQUARE FLANGE¹⁾

BODY STYLE

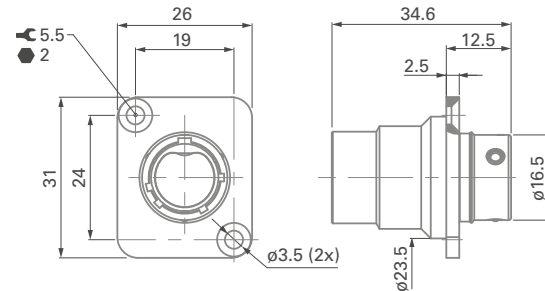

Part number	Description
FOH R13LGR1 00A00 A 000	FOH - R13 Receptacle
FOH R03-R13 WIRE SET L26 D8	FOH - R03-R13 Receptacle wire set
FOH R03-R13 POTTING SET L54 D10.8 ²⁾	FOH - R03-R13 Receptacle potting set

REAR ACCESSORIES

WIRE SET

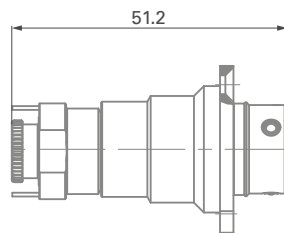

POTTING SET

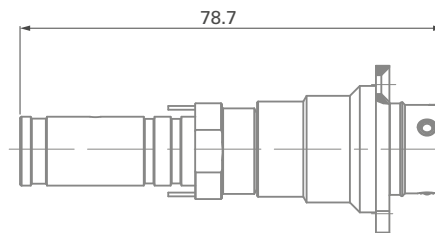

PANEL CUT-OUT

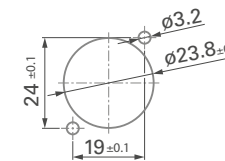

¹⁾ Due to panel mounting with screws, sealing can't be guaranteed at panel level.

²⁾ The last number indicates the max compatible cable diameter in mm.

Note: indicated connector P/N = delivered without contacts, termini and rear accessory

All dimensions and images shown are in millimeters and are for reference only.

OPTICAL TERMINI AND ELECTRICAL CONTACTS

FIBEROPTIC



Designation	Part Number
Singlemode terminus	FO TERMINI SMA PC



Multimode terminus	FO TERMINI MMA PC
--------------------	-------------------



Electrical contact (FOH Only)	FO Termini EL M ϕ 1.25 SR A
-------------------------------	----------------------------------

CONNECTORS

Example:

FO Type		Housing design				Contacts			Rear accessory	Modification code
FO	4	P01	L	GR	1	04	S	00	W	000

Series

- FO = FiberOptic Series

Number of channels (optic +Electric)

- 1 = Single channel
- 2 = Two channels
- 4 = Four channels
- H = Hybrid

Body style

Plugs

- P01 = Cable mounted

Receptacles

- R01 = Panel rear mounted, circular flange
- R03 = Panel front mounted, circular flange
- R13 = Panel front mounted, rectangular flange
- R50 = Cable mounted

Locking system

- L = Push-pull locking system

Housing color

- GR = Grey

Keying code

- 1 = Code 1

Modification code

- 000 = Default

Rear accessory

- A = Delivered without rear accessory
- W = Delivered with wire set accessory
- C = Delivered with cable clamp set accessory
- P = Delivered with potting set accessory

Number of electrical contacts (FOH only)

- 00 = Delivered without electrical contact
- 01 = Delivered with one electrical contact
- 02 = Delivered with two electrical contacts
- 03 = Delivered with three electrical contacts
- 04 = Delivered with four electrical contacts

Optical contact type

- A = Delivered without optical terminus
- S = Single-mode optical terminus
- M = Multi-mode optical terminus

Number of optical termini

- 00 = Delivered without optical terminus
- 01 = Delivered with one optical terminus
- 02 = Delivered with two optical termini
- 03 = Delivered with three optical termini
- 04 = Delivered with four optical termini

FIBEROPTIC

CABLED PRODUCTS

FIBEROPTIC

Example:

Nbr.		End A			Cable					End B			Options		
FO	2	P01	P	0	S9	002.	0	00.	0	P01	P	0	A	A	A

Series

- **FiberOptic** = FO
- **FiberOptic hybrid** = FOH

Fiber count

- **1** = Single channel
- **2** = Two channels
- **4** = Four channels
- **2-2** = Hybrid 2+2

A-End connector body style

Plugs

- **P01** = Cable mounted plug

Receptacles

- **R01** = Panel rear mounted, circular flange
- **R03** = Panel front mounted, circular flange
- **R13** = Panel front mounted, rectangular flange
- **R50** = Cable mounted

Other connectors ¹⁾

- **CNA** = Free-end
- **CLC** = LC
- **CSC** = SC
- **CFC** = FC
- **CST** = ST

Cable fixture

- **N** = None (not cable potting or clamping)
- **C** = Cable clamp
- **P** = Potting

Contact polishing

Single-mode

- **0°** = PC
- **8°** = APC

Multi-mode

- **0°** = PC

Fiber type

- **S9** = Single-mode 9/125
- **M5** = Multi-mode 50/125
- **M6** = Multi-mode 62.5/125

Total length L [meters]

Break-out length L_B [meters]

for breakout & sealed (if applicable / min. 0.3, max. 1.0)

Supply source

- **A** = OCC
- **B** = DRAKA
- **C** = LEONI
- **D** = BRUGG
- **E** = KAIPHONE
- **Z** = Customer project

Application environment

- **A** = Indoor / outdoor
- **B** = Outdoor rodent
- **C** = Outdoor armored
- **Z** = Specific / custom

Packaging

- **A** = Cardboard box
- **B** = Bag
- **R** = Reel

A = Up to 20 meters length (10 meters for rodent and armored cables). From 20.1 meters length (10 meters for rodent and armored cables), select B.
 B = Available from 20.1 to 49.9 meters. From 50 meters length, select R.
 R = from 50 meters length, cable assemblies are delivered on a reel.

Contact polishing

Single-mode

- **0°** = PC
- **8°** = APC

Multi-mode

- **0°** = PC

No connector on end B

- **Z** = Not applicable

Cable fixture

- **N** = None (not cable potting nor clamping)
- **C** = Cable clamp
- **P** = Potting

B-End connector body style

Plugs

- **P01** = Cable mounted plug

Receptacles

- **R01** = Panel rear mounted, circular flange
- **R03** = Panel front mounted, circular flange
- **R13** = Panel front mounted, rectangular flange
- **R50** = Cable mounted

Other connectors

- **CNA** = Free-end
- **CLC** = LC
- **CSC** = SC
- **CFC** = FC
- **CST** = ST

¹⁾ Only for reel packaging option (R).

SOFT CAPS

FOR PLUGS

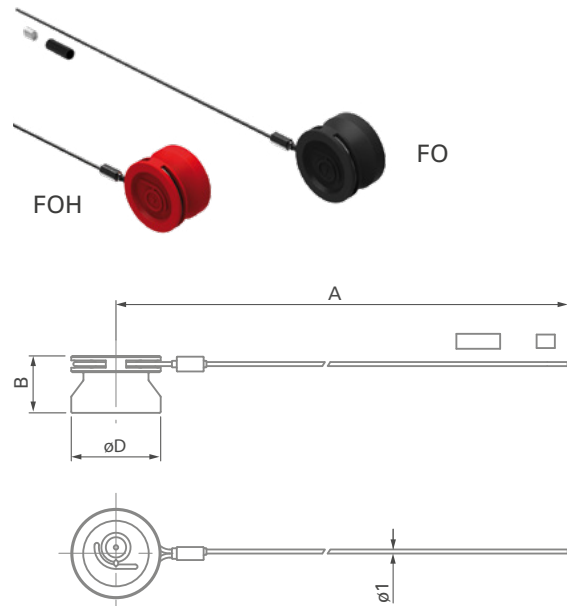

Body size & style		Part number	A	B	øD
FO1	P01	FOCP06C 1B2 A120	120	10.5	13
FO2/4	P01	FOCP14C 1B2 A150	150	14.0	22
FOH	P01	FOHCP14C 1B2 A150	150	14.0	22

Crimp ferrule and heat shrink tube are included.

FOR RECEPTACLES

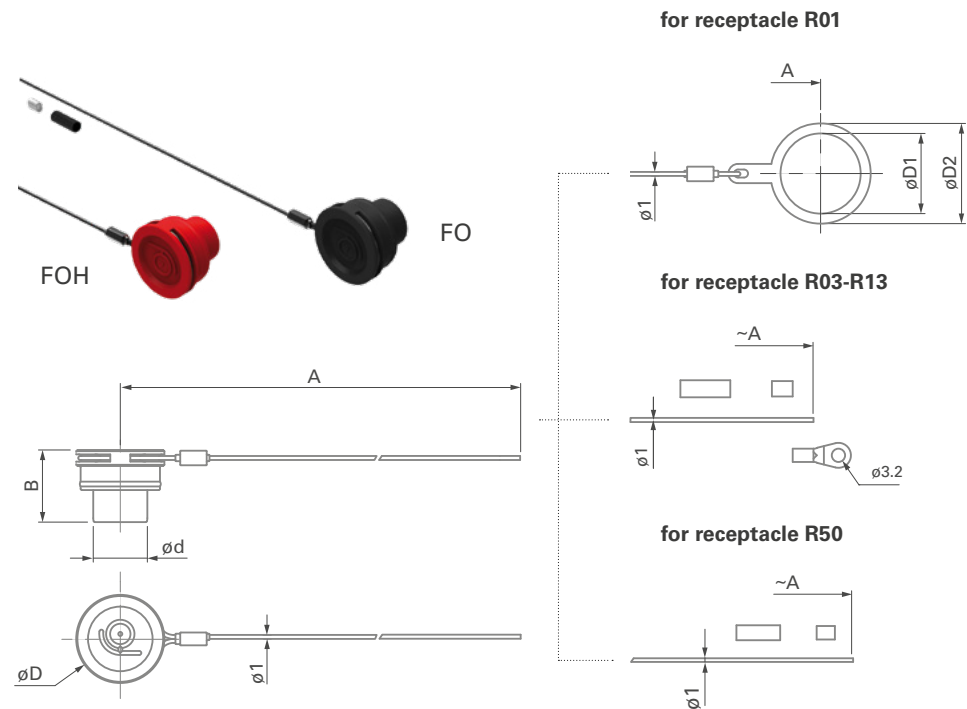

Body size & style		Part number	A	B	ød	øD	øD1	øD2
FO1	R01	FOCR06P 1B2 A70	70	11.5	6.0	13	10	14
	R03-R13	FOCR06P 1B2 E150	150				-	-
	R50	FOCR06C 1B2 A120	120				-	-
FO2/4	R01	FOCR14P 1B2 A110	110	14.0	13.5	22	20	25
	R03-R13	FOCR14P 1B2 E150	150	14.0	13.5	22	-	-
	R50	FOCR14C 1B2 A150					-	-
FOH 2-2	R01	FOHCR14P 1B2 A110	110	14.0	13.5	22	20	25
	R03-R13	FOHCR14P 1B2 E150	150	14.0	13.5	22	-	-
	R50	FOHCR14C 1B2 A150					-	-

All dimensions and images shown are in millimeters and are for reference only.

DAISY CHAINING



Fiber type	Fiber count	Part number
SM 9 (G657.A1)	2	FO2 DC 0 S9 AAA
	4	FO4 DC 0 S9 AAA
	Hybrid	FOH2-2 DC 0 S9 AAA
MM 50 (OM3)	2	FO2 DC 0 M5 AAA
	4	FO4 DC 0 M5 AAA
	Hybrid	FOH2-2 DC 0 M5 AAA
MM 62.5 (OM1+)	2	FO2 DC 0 M6 AAA
	4	FO4 DC 0 M6 AAA
	Hybrid	FOH2-2 DC 0 M6 AAA
Pin layout	Applies to all configurations	

LOOPBACK



Fiber type	Fiber count	Part number
SM 9 (G657.A1)	4	FO4 LB 0 S9 AAA
MM 50 (OM3)	4	FO4 LB 0 M5 AAA
MM 62.5 (OM1+)	4	FO4 LB 0 M6 AAA
Pin layout	Applies to all configurations	

The use of caps is recommended for maximum robustness during handling.

PRE-CONFIGURED FIBEROPTIC REELS



		50 meter reels		100 meter reels	
Fiber type	Fiber count	Part number	Part number	Part number	Part number
SM 9 (G657.A1)	1	FO1 P01P0 S9-050.0-00.0 P01P0 RAA	FO1 P01P0 S9-100.0-00.0 P01P0 RAA	FO1 P01P0 S9-100.0-00.0 P01P0 RAA	FO1 P01P0 S9-100.0-00.0 P01P0 RAA
	2	FO2 P01P0 S9-050.0-00.0 P01P0 RAC	FO2 P01P0 S9-100.0-00.0 P01P0 RAC	FO2 P01P0 S9-100.0-00.0 P01P0 RAC	FO2 P01P0 S9-100.0-00.0 P01P0 RAC
	4	FO4 P01P0 S9-050.0-00.0 P01P0 RAC	FO4 P01P0 S9-100.0-00.0 P01P0 RAC	FO4 P01P0 S9-100.0-00.0 P01P0 RAC	FO4 P01P0 S9-100.0-00.0 P01P0 RAC
	Hybrid	FOH2-2 P01P0 S9-050.0-00.0 P01P0 RAC	FOH2-2 P01P0 S9-100.0-00.0 P01P0 RAC	FOH2-2 P01P0 S9-100.0-00.0 P01P0 RAC	FOH2-2 P01P0 S9-100.0-00.0 P01P0 RAC
MM 50 (OM3)	1	FO1 P01P0 M5-050.0-00.0 P01P0 RAA	FO1 P01P0 M5-100.0-00.0 P01P0 RAA	FO1 P01P0 M5-100.0-00.0 P01P0 RAA	FO1 P01P0 M5-100.0-00.0 P01P0 RAA
	2	FO2 P01P0 M5-050.0-00.0 P01P0 RAC	FO2 P01P0 M5-100.0-00.0 P01P0 RAC	FO2 P01P0 M5-100.0-00.0 P01P0 RAC	FO2 P01P0 M5-100.0-00.0 P01P0 RAC
	4	FO4 P01P0 M5-050.0-00.0 P01P0 RAC	FO4 P01P0 M5-100.0-00.0 P01P0 RAC	FO4 P01P0 M5-100.0-00.0 P01P0 RAC	FO4 P01P0 M5-100.0-00.0 P01P0 RAC
	Hybrid	FOH2-2 P01P0 M5-050.0-00.0 P01P0 RAC	FOH2-2 P01P0 M5-100.0-00.0 P01P0 RAC	FOH2-2 P01P0 M5-100.0-00.0 P01P0 RAC	FOH2-2 P01P0 M5-100.0-00.0 P01P0 RAC
		150 meter reels		200 meter reels	
Fiber type	Fiber count	Part number	Part number	Part number	Part number
SM 9 (G657.A1)	1	FO1 P01P0 S9-150.0-00.0 P01P0 RAA	FO1 P01P0 S9-200.0-00.0 P01P0 RAA	FO1 P01P0 S9-200.0-00.0 P01P0 RAA	FO1 P01P0 S9-200.0-00.0 P01P0 RAA
	2	FO2 P01P0 S9-150.0-00.0 P01P0 RAC	FO2 P01P0 S9-200.0-00.0 P01P0 RAC	FO2 P01P0 S9-200.0-00.0 P01P0 RAC	FO2 P01P0 S9-200.0-00.0 P01P0 RAC
	4	FO4 P01P0 S9-150.0-00.0 P01P0 RAC	FO4 P01P0 S9-200.0-00.0 P01P0 RAC	FO4 P01P0 S9-200.0-00.0 P01P0 RAC	FO4 P01P0 S9-200.0-00.0 P01P0 RAC
	Hybrid	FOH2-2 P01P0 S9-150.0-00.0 P01P0 RAC	FOH2-2 P01P0 S9-200.0-00.0 P01P0 RAC	FOH2-2 P01P0 S9-200.0-00.0 P01P0 RAC	FOH2-2 P01P0 S9-200.0-00.0 P01P0 RAC
MM 50 (OM3)	1	FO1 P01P0 M5-150.0-00.0 P01P0 RAA	FO1 P01P0 M5-200.0-00.0 P01P0 RAA	FO1 P01P0 M5-200.0-00.0 P01P0 RAA	FO1 P01P0 M5-200.0-00.0 P01P0 RAA
	2	FO2 P01P0 M5-150.0-00.0 P01P0 RAC	FO2 P01P0 M5-200.0-00.0 P01P0 RAC	FO2 P01P0 M5-200.0-00.0 P01P0 RAC	FO2 P01P0 M5-200.0-00.0 P01P0 RAC
	4	FO4 P01P0 M5-150.0-00.0 P01P0 RAC	FO4 P01P0 M5-200.0-00.0 P01P0 RAC	FO4 P01P0 M5-200.0-00.0 P01P0 RAC	FO4 P01P0 M5-200.0-00.0 P01P0 RAC
	Hybrid	FOH2-2 P01P0 M5-150.0-00.0 P01P0 RAC	FOH2-2 P01P0 M5-200.0-00.0 P01P0 RAC	FOH2-2 P01P0 M5-200.0-00.0 P01P0 RAC	FOH2-2 P01P0 M5-200.0-00.0 P01P0 RAC
		300 meter reels		450 meter reels	
Fiber type	Fiber count	Part number	Part number	Part number	Part number
SM 9 (G657.A1)	1	FO1 P01P0 S9-300.0-00.0 P01P0 RAA	FO1 P01P0 S9-450.0-00.0 P01P0 RAA	FO1 P01P0 S9-450.0-00.0 P01P0 RAA	FO1 P01P0 S9-450.0-00.0 P01P0 RAA
	2	FO2 P01P0 S9-300.0-00.0 P01P0 RAC	FO2 P01P0 S9-450.0-00.0 P01P0 RAC	FO2 P01P0 S9-450.0-00.0 P01P0 RAC	FO2 P01P0 S9-450.0-00.0 P01P0 RAC
	4	FO4 P01P0 S9-300.0-00.0 P01P0 RAC	FO4 P01P0 S9-450.0-00.0 P01P0 RAC	FO4 P01P0 S9-450.0-00.0 P01P0 RAC	FO4 P01P0 S9-450.0-00.0 P01P0 RAC
	Hybrid	FOH2-2 P01P0 S9-300.0-00.0 P01P0 RAC	-	-	-
MM 50 (OM3)	1	FO1 P01P0 M5-300.0-00.0 P01P0 RAA	FO1 P01P0 M5-450.0-00.0 P01P0 RAA	FO1 P01P0 M5-450.0-00.0 P01P0 RAA	FO1 P01P0 M5-450.0-00.0 P01P0 RAA
	2	FO2 P01P0 M5-300.0-00.0 P01P0 RAC	FO2 P01P0 M5-450.0-00.0 P01P0 RAC	FO2 P01P0 M5-450.0-00.0 P01P0 RAC	FO2 P01P0 M5-450.0-00.0 P01P0 RAC
	4	FO4 P01P0 M5-300.0-00.0 P01P0 RAC	FO4 P01P0 M5-450.0-00.0 P01P0 RAC	FO4 P01P0 M5-450.0-00.0 P01P0 RAC	FO4 P01P0 M5-450.0-00.0 P01P0 RAC
	Hybrid	FOH2-2 P01P0 M5-300.0-00.0 P01P0 RAC	-	-	-

Assembled on Schill drum with OCC cable (FO1) and LEONI cable (FO2, FO4, FOH 2-2).

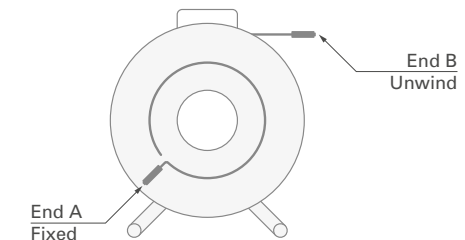

FIBEROPTIC

COLOR CODING SILICONE RING



FO1 – FOCR06

- Beige Red
- Blue Green

FO2/4/H – FOCR14

- Beige Red
- Blue Green

OPEN SPANNER



FO1

- TX00.004 TX00.014
- TX00.011

FO2/4/H

- TX00.019
- TX00.025

HEXAGON SPANNER



FO1 - R13

- TX00.384

NUT DRIVER



FO1

- TC00.007

FO2/4/H

- TP00.013

SLEEVES HOLDER MATE ADAPTER



FO1

- FOP06 Sleeve Holder



FO2/FO4

- FOP14 Sleeve Holder

PANEL SEAL



FO1

- FO R13 Panel Seal FO1



FO2/4/H

- FO R13 Panel Seal FO2/4/H

TELECOM MATE ADAPTER



- LC Adapter SM/APC
- LC Adapter SM/UPC
- LC Adapter MM/UPC



- SC Adapter SM/APC
- SC Adapter SM/UPC
- SC Adapter MM/UPC



- FC Adapter SM/APC
- FC Adapter SM-MM



- ST Adapter SM-MM

PRE-CABLED REEL*



- GT235.RM
- GT310.RM
- GT380.RMFK
- GT450.RMFK
- HT582.RM

WEDGE CLAMP JAWS



- Wedge Clamp Black Jaws

FIBER OPTIC CLEANING KIT



- FO Cleaning Kit (complete kit)**
- Cleaning kit components
- Laser pen
- Laser pen adapter
- IBC brand cleaner H125
- Precision tweezers
- 50 alcohol wipes

* Pre-configured reels can be found on page I-27.
Reel selection can vary following cable choice and length.

Contact your local sales for details or visit: www.fischerconnectors.com/fiberoptic

MATERIAL & SURFACE FINISH

Metal components	Material		Finish	
	Designation ISO	Standard	Designation	Standard
Housing, nut	Brass CuZn39Pb3	CW614N	Chrome over Nickel	SAE-AMS 2460
		UNS C 38500		
Back nut (plug) FO1	Brass CuZn39Pb3	CW614N	Black Chrome over Nickel	SAE-AMS 2460
		UNS C 38500		
Back nut (plug) FO2, FO4, FOH	Brass CuZn39Pb3	CW614N	Nickel	SAE-AMS-QQ-N-290
		UNS C 38500		SAE-AMS 2404
Electrical contact	Brass CuZn39Pb3	CW614N UNS C 38500	1 µm Gold over Nickel	MIL-DTL-45204D Type 1 + ASTM B488 / SAE-AMS- QQ-N-290 / SAE-AMS 2404
Shell contact	Stainless steel	X5CrNiMo18-10 (1.4401)	-	-
Spring	Stainless steel	X10CrNi18-8 (1.4310)	-	-
Mantel clip	Stainless steel	X5CrNiMo18-10 (1.4401)	-	-
Sleeve holder (plug) FO1	Brass CuZn39Pb3	CW614N	Nickel	SAE-AMS-QQ-N-290
		UNS C 38500		SAE-AMS 2404
Sleeve holder (center pin) FO2, FO4, FOH	Stainless steel	X8CrNiS18-9 (1.4305)	-	-
Locking balls	Stainless steel	X46Cr13 (1.4034)	-	-

Non-metallic components	Material	Flammability
Ferrules & sleeves	Zirconia	-
Contact housing	LCP	UL 94 V-0
Contact block & sleeve holder	PBT	UL 94 V-0
	PEEK	-
Mantel ring	PTFE	UL 94 V-0
O-rings	FPM (Viton®)	-
	NBR (Nitrile)	-
Sealant material	Epoxy compound	-
Cable strain relief	TPE	UL 94 HB
Caps	TPE	UL 94 HB
Locking protection sleeve	TPE	UL 94 HB

FIBEROPTIC

ENVIRONMENTAL & MECHANICAL DATA

Characteristic	Performance	Standard
Sealing mated	IP68; 2 m submersion for 24 hours ¹⁾	IEC 60529
Sealing unmated	IP67 ¹⁾	IEC 60529
Operating temperature range	-40 °C to +85 °C (cable dependent)	IEC 61300-2-22
Vibration	Sinusoidal, 10 - 55 Hz, 3 axes, 0.75 mm amplitude (max 10 g) ¹⁾	IEC 61300-2-1
Shock	100 g ¹⁾	IEC 61300-2-9
Salt mist	1000 hours, 5% salt solution, 35 °C ¹⁾²⁾	IEC 61300-2-26
Mating durability	1000 mating cycles ¹⁾³⁾	IEC 61300-2-2

¹⁾Exceeds IEC 61753-1 Cat.E Extreme Environment. Fischer Connectors can offer FO cable assemblies that are sealed to IP68 deeper than 2 m on request.

²⁾Connector must be mated

³⁾Recommended cleaning every 50 cycles.

FIBER TYPE AND PIN LAYOUT

Contact type		Fiber standards
Single-mode 9/125	UPC	G.657.A1
Single-mode 9/125	APC	
Multi-mode 50/125	-	OM3
Multi-mode 62.5/125	-	OM1 / OM1+

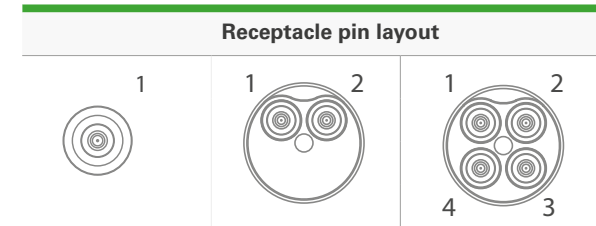
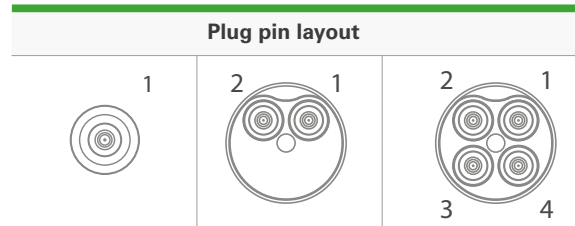

OPTICAL DATA

Characteristic	Performance	Standard
Insertion loss	SM and MM	≤0.20 dB mean
		≤0.45 dB max for >97% of samples
		≤0.2 dB change during and after testing
		IEC 61300-3-34 Random mated
		IEC 61300-3-3
Return loss	SM UPC	≥50 dB
	SM APC	≥70 dB (mated) and ≥50 dB (unmated)
		IEC 61300-3-6 Random mated

ELECTRICAL DATA - FOH 2-2

Characteristic	Performance	Standard
Number of contacts	2 contacts, ground by shell	-
Current	10 [A] ¹⁾	IEC 60512-5-2-5b
Rated voltage	400 [V] r.m.s. ²⁾	EIA-364-20-B
Contact resistance (power contact)	< 10 mΩ	IEC 60512-2-1, Test 2a
Contact resistance (ground contact)	< 50 mΩ	IEC 60512-2-1, Test 2a
Insulation resistance	> 10 ¹⁰ Ω	IEC 60512-3-1-3a Method C
Contact termination	Solder	-
Wire size	AWG17 / 1 mm ²	-
Test voltage AC	1.5 [kV] r.m.s	IEC 60512-4-1 Test 4a
Test voltage DC	2.8 [kV]	IEC 60512-4-1 Test 4a

¹⁾ Current per contact at 40°C temperature rise measured on the basic curve according to IEC 60512-5-2-5b. Please refer to section A-12 to determine the maximum operating current.

²⁾ Recommended operating voltage at sea level measured according to IEC 60664-1. Please refer to A-11

CONFIGURE YOUR SOLUTION

Quantity - Please use one request form per cable assembly type

Cable assembly types		
	End A	End B
Patch cord		
Receptacle		
Sealed receptacle		
Breakout		
Single Fiber		

Drawings are for reference only. Available for FO1, FO2, FO4 and FOH 2-2

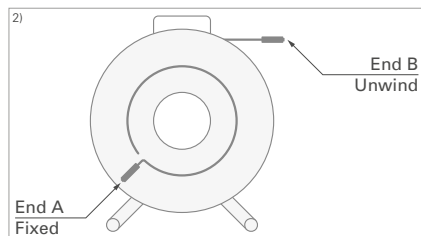

All images shown are for reference only.

DOWNLOAD REQUEST QUOTE FORM







End A	Assembly	End B
FiberOptic connectors <input type="checkbox"/> P01 - Plug <input type="checkbox"/> R50 - Receptacle cable mounted <input type="checkbox"/> R01 - Receptacle panel rear mounted <input type="checkbox"/> R03 - Receptacle panel front mounted <input type="checkbox"/> R13 - Receptacle panel square flange <input type="checkbox"/> CNA - Free end No Connector ²⁾	Total length L_{tot} ¹⁾ <i>end-to-end total (min. 0.5 except receptacles)</i> <input type="checkbox"/> 1 meter <input type="checkbox"/> 2 meters Breakout length L_b ¹⁾ <i>for breakout & sealed (if applicable / min. 0.3, max. 1.0)</i> <input type="checkbox"/> 0.5 meter <input type="checkbox"/> 1 meter Telecom connector ²⁾ <input type="checkbox"/> LC <input type="checkbox"/> SC <input type="checkbox"/> FC <input type="checkbox"/> ST Short length receptacles <i>For receptacles < 0.5 meters 900 μm buffered fibers wires</i>	FiberOptic connectors <input type="checkbox"/> P01 - Plug <input type="checkbox"/> R50 - Receptacle cable mounted <input type="checkbox"/> R01 - Receptacle panel rear mounted <input type="checkbox"/> R03 - Receptacle panel front mounted <input type="checkbox"/> R13 - Receptacle panel square flange <input type="checkbox"/> CNA - Free end No Connector Telecom connector <input type="checkbox"/> LC <input type="checkbox"/> SC <input type="checkbox"/> FC <input type="checkbox"/> ST Contact End-face <i>Available for SM only</i> <input type="checkbox"/> 0° PC <input type="checkbox"/> 8° APC Short length receptacles <i>For receptacles \geq 0.5 meters 2.0 mm tight buffered wires</i>

¹⁾ Cable length in 0.1 meter units only.
 Cable length tolerance according IPC-WHMA-A-620.
²⁾ Only for reel packaging option (R).



CHOOSE YOUR CABLE

FIBEROPTIC

INDOOR/OUTDOOR

Supplier Brand	Fiber Count	SM 9/125 G.657.A1	MM 50/125 OM3	MM 62.5/125 OM1 /OM1+	
OCC	1	<input type="checkbox"/>	<input type="checkbox"/>	<input type="checkbox"/>	
	2	<input type="checkbox"/>	<input type="checkbox"/>	<input type="checkbox"/>	
	4	<input type="checkbox"/>	<input type="checkbox"/>	<input type="checkbox"/>	
LEONI	2	<input type="checkbox"/>	<input type="checkbox"/>	<input type="checkbox"/>	
	4	<input type="checkbox"/>	<input type="checkbox"/>	<input type="checkbox"/>	
LEONI	Hybrid 2+2	<input type="checkbox"/>	<input type="checkbox"/>	<input type="checkbox"/>	

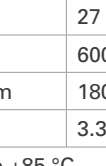
RODENT PROOF

Supplier Brand	Fiber Count	SM 9/125 G.657.A1	MM50/125 OM3	MM 62.5/125 OM1 /OM1+	
LEONI Glass Fiber	2	<input type="checkbox"/>	<input type="checkbox"/>	<input type="checkbox"/>	
	4	<input type="checkbox"/>	<input type="checkbox"/>	<input type="checkbox"/>	
METAL ARMORED					
KAIPHONE	1	<input type="checkbox"/>	<input type="checkbox"/>	<input type="checkbox"/>	
BRUGG	2	<input type="checkbox"/>	<input type="checkbox"/>	<input type="checkbox"/>	
	4	<input type="checkbox"/>	<input type="checkbox"/>	<input type="checkbox"/>	

See our Cable Specifications for detailed information.

Available Available under special lead time - please contact your local sales department for details.

Outdoor cable features	OCC		LEONI	LEONI	KAIPHONE	BRUGG
	FO1	FO2, FO4	FO2, FO4	FO2, FO4	FO1	FO2, FO4
Best for	Premium application		High load application	Rodent proof	Metal armored	Metal armored
	<ul style="list-style-type: none"> - Overall ruggedness - Easy deployment - High end tactical cable 		<ul style="list-style-type: none"> - High load resistance - Easy deployment - High end tactical cable 	<ul style="list-style-type: none"> - Semi-static applications - Easy deployment - Dielectric rodent protection - High flexibility 	<ul style="list-style-type: none"> - High rodent protection - Static & deployable applications - Ultra-light armored technology - Sensing applications 	<ul style="list-style-type: none"> - High rodent protection - Static & deployable applications - Self supporting applications - Ultra-light armored technology - Direct burial
Technology	<ul style="list-style-type: none"> - Tight buffered fibers - Aramid yarn - PUR jacket 		<ul style="list-style-type: none"> - Tight buffered fibers - Aramid yarn - PUR jacket 	<ul style="list-style-type: none"> - Tight buffered fibers - Aramid yarn / - PUR double skin jacket 	<ul style="list-style-type: none"> - Stainless steel loose tube - Aramid yarn - LDPE jacket 	<ul style="list-style-type: none"> - Stainless steel loose tube - Stainless steel yarn - PA Jacket
Outer diameter	2.9 mm	5.5 mm	5.5 mm	9.4 mm	3.0 mm	3.8 mm
Weight	8 kg/km	27 kg/km	28 kg/km	105 kg/km	18 kg/km	25 kg/km
Operating tensile load	300 N	600 N	1500 N	2000 N	300 N	900 N
Crush resistance	500 N/cm	1800 N/cm	800 N/cm	800 N/cm	300 N/cm	800 N/cm
Min. bend radius	1.5 cm	3.3 cm	5.5 cm	9.4 cm	3.0 cm	5.7 cm
Operating temperature	-40 °C to +85 °C		-55 °C to +85 °C	-55 °C to +85 °C	-40 °C to + 85 °C	-40 °C to + 70 °C